

### 4.5 Models 129, 140 up to 05/96, 202 as of 12/94, 210 up to 05/96

	Page
<b>Diagnosis</b>	
Function Test .....	11/1
Diagnostic Trouble Code (DTC) Memory .....	12/1
<b>Electrical Test Program</b>	
Component Locations .....	20/1
Connection of Components .....	21/1
Preparation for Test .....	22/1
Test .....	23/1
<b>Hand-Held Tester (HHT)</b>	
Version Coding and Programming .....	31/1



#### Actual values:

Via the Hand-Held-Tester (HHT) up to 8 different IR transmitter keys can be tested for locking approval. Additionally, the battery condition and synchronization of each individual IR transmitter can be tested. The Hand-Held-Tester also indicates the number of recently currently used IR transmitter. Lastly, an indication is given if the RCL control module (N54) is “married” (via an identification code) to the vehicle. The readout of actual values is menu driven.

#### De-synchronization

Loss of an IR transmitter key requires the de-synchronization of the RCL control module (N54) and the replacement of the mechanical locks. De-synchronization is only possible using the HHT and is menu driven. After de-synchronization, all still existing IR transmitter keys must be synchronized (see owner’s manual).

#### Blocking IR transmitter keys

Via the HHT, IR transmitter keys can be **irrevocably** locked (only upon vehicle owner’s consent). The blocking of individual IR transmitter keys is menu driven.

#### Version coding

Replacement of RCL control modules requires version coding via the HHT. The version coding is menu driven.

#### CAUTION!

The RCL control module (N54) and engine control module are “married” together via an identification code exchange. These identification codes can not be changed and this code remains with the vehicle for its service life. Only the mechanical locks can be replaced.

#### If the customer loses an IR transmitter key (which includes a mechanical key):

The vehicle’s RCL identification code remains, the lost IR transmitter key (s) is de-synchronized via the RCL control module. To maintain vehicle security, all mechanical locks should be replaced using a new mechanical lock number code. You must notify your facing PDC of any mechanical lock changes, by using the Lock Change Notice Form.

#### If the RCL control module is defective:

A new RCL control module must be specially ordered for the specific vehicle, using the same RCL identification code as the previously installed RCL control module. Therefore, it is impossible to swap control modules (either RCL or engine control modules) for troubleshooting purposes.

#### If a mechanical lock or key is defective:

Replace the mechanical lock or key with a new one, using the same mechanical lock code number (special order from your facing PDC).

#### Additional Information:

Please review S.I. 80/22, All Models, Model year 1996, Infrared Remote Central locking (RCL), September 1995 for details.

### **Blocking IR transmitter keys**

Via the HHT, IR transmitter keys can be **irrevocably** locked (only upon vehicle owner's consent). The blocking of individual IR transmitter keys is menu driven.

### **Version coding**

Replacement of RCL control modules requires version coding via the HHT. The version coding is menu driven.

### **CAUTION!**

The RCL control module (N54) and engine control module are "married" together via an identification code exchange. These identification codes can not be changed and this code remains with the vehicle for its service life. Only the mechanical locks can be replaced.

### **If the customer loses an IR transmitter key (which includes a mechanical key):**

The vehicle's RCL identification code remains, the lost IR transmitter key (s) is de-synchronized via the RCL control module. To maintain vehicle security, all mechanical locks should be replaced using a new mechanical lock number code. You must notify your facing PDC of any mechanical lock changes, by using the Lock Change Notice Form.

### **If the RCL control module is defective:**

A new RCL control module must be specially ordered for the specific vehicle, using the same RCL identification code as the previously installed RCL control module. Therefore, it is impossible to swap control modules (either RCL or engine control modules) for troubleshooting purposes.

### **If a mechanical lock or key is defective:**

Replace the mechanical lock or key with a new one, using the same mechanical lock code number (special order from your facing PDC).

### **Additional Information:**

Please review S.I. 80/22, All Models, Model year 1996, Infrared Remote Central locking (RCL), September 1995 for details.

Diagnosis – Function Test

Preliminary work: Check operation of central locking;  
Check batteries in infrared transmitter key,  
see SMS, Job No. .... 80-420

Model 202

As of M.Y. 1996, single RCL receiver (interior rearview mirror) (A26/7)

Note:

On RCL control modules with the part numbers 210 820 27 26 and 210 820 28 26, the following functional changes are noted:

- For a time period of approximately 2 seconds after the ignition is switched OFF, use of the RCL system is not possible.
- If unintentionally locked and if the ignition is switched on within 2 seconds, the vehicle will automatically unlock along with authorization given via ECM for engine start.

Figure 1

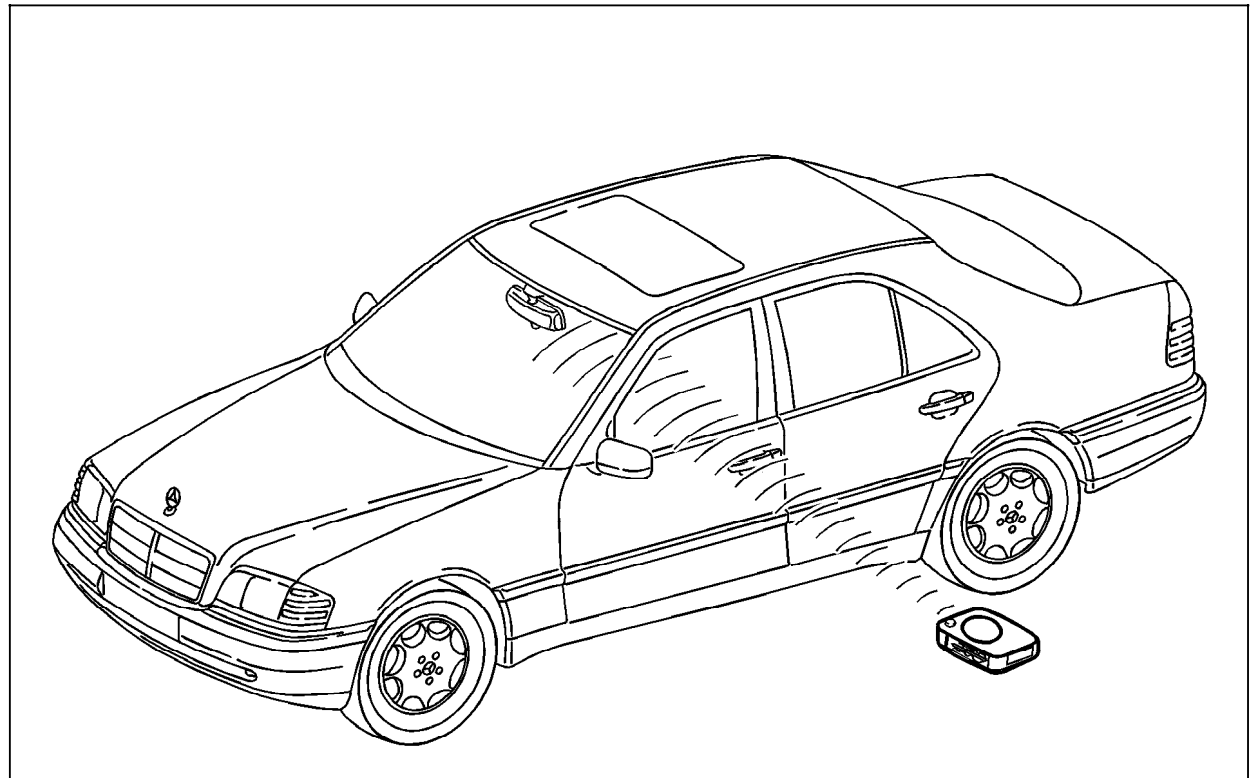

P80.30-0219-57

## 4.5 Infrared Remote Central Locking (RCL)

Models 129, 140, 202 as of M.Y. 1996, 210 up to 06/96

### Diagnosis – Function Test

#### Preparation for Test:

1. Battery voltage 11 – 14 V,
2. **Model 129:** Fuse F1–15, F20–6 ok,
3. **Model 140:** Fuse F4–2, F4–15 ok,
4. **Model 202:** Fuse F1–23, F3–27 ok,
5. **Model 210:** fuse F1–14, F1–17, F1–22, F4–3 ok,
6. Central locking system in proper operating condition,
7. Batteries in IR transmitter ok,
8. IR transmitter synchronized,
9. Key removed from steering lock,
10. Side windows lowered approx. 100 mm (4 in.),
11. Sliding/pop-up roof open,
12. All doors and trunk lid closed,
13. Central locking system unlocked.

#### Significance of the indicator lamps

Green	Red	Green and red alternating	Green and red simultaneously	Blink time	Significance	Possible cause/Remedy
X				Approx. 3 seconds	Approved deactivation, vehicle is unlocked.	
	X			Approx. 3 seconds	Approved activation, vehicle is locked.	
		X		Approx. 30 seconds	Engine management disabled.	⇒ 6.0
			X	Approx. 30 seconds	IR transmitter batteries-low voltage	Replace IR transmitter batteries

## 4.5 Infrared Remote Central Locking (RCL)

Models 129, 140, 202 as of M.Y. 1996, 210 up to 06/96

### Diagnosis – Function Test

Test step/Test scope	Test condition	Nominal value	Possible cause/Remedy <sup>1)</sup>
⇒ 1.0 Locking of vehicle with infrared remote control via RCL receiver (interior rearview mirror) (A26/7).	Lock vehicle using IR transmitter.	Vehicle is locked. Red indicator lamps (RCL receiver, interior rearview mirror and left front door) blink for a maximum of approx. 3 seconds.	23 ⇒ 1.0 – 5.0, 9.0 – 11.0, 15.0 – 20.0
⇒ 2.0 Unlocking of vehicle with infrared remote control via RCL receiver (interior rearview mirror) (A26/7).	Unlock vehicle using IR transmitter.	Vehicle is unlocked. Green indicator lamps (RCL receiver, interior rearview mirror and left front door) blink for a maximum of approx. 3 seconds.	23 ⇒ 1.0 – 4.0, 6.0 – 8.0, 12.0 – 14.0, 17.0 – 20.0
⇒ 3.0 Close side windows and sliding/pop-up roof with infrared remote control.	Point IR transmitter towards RCL receiver (interior rearview mirror) and press IR transmitter button for > 1 second.	Side windows and sliding/pop-up roof close.	23 ⇒ 1.0 – 5.0, 9.0 – 11.0, 15.0 – 20.0
⇒ 4.0 Open side windows with infrared remote control.	After side windows close, within 8 seconds (models 140, 202), 3 seconds (model 129), and 5 seconds (model 210), point IR transmitter towards RCL receiver (interior rearview mirror). And then press transmitter button for > 4 seconds.	Side windows open.	23 ⇒ 1.0 – 4.0, 6.0 – 8.0, 12.0 – 14.0, 17.0 – 20.0
⇒ 5.0 Disable engine management.	Lock vehicle using IR transmitter. Try to start engine.	Engine does not start.	12, 23 ⇒ 1.0 – 33.0, DTC memory, engine.

<sup>1)</sup> Observe Preparation for Test, see 22.

### Diagnosis – Function Test

Test step/Test scope	Test condition	Nominal value	Possible cause/Remedy <sup>1)</sup>
⇒ 6.0 Enable engine management.	Unlock vehicle using IR transmitter. Try to start engine.	Engine starts.	12, 23 ⇒ 1.0 – 33.0, DTC memory (HFM-SFI, ME-SFI), Actual values (HFM-SFI, ME-SFI).
⇒ 7.0 Open trunk lid with infrared remote control.	Trunk lid lock key slot is <b>not</b> in 90° (key can be removed) position. Lock vehicle using IR transmitter. Point IR transmitter towards RCL receiver (interior rearview mirror) and press IR transmitter button <b>twice</b> within 0.8 seconds.	Trunk lid opens. Retractable trunk lid grip extends <sup>2)</sup>	23 ⇒ 1.0 – 4.0, 6.0 – 8.0, 12.0 – 14.0, 17.0 – 20.0 PSE electrical/pneumatic fault, Trunk lid lock mechanical fault.

1) Observe Preparation for Test, see 22.

2) Model 140 only

Diagnosis – Diagnostic Trouble Code (DTC) Memory

Preliminary work:

Function test ..... 11

Preparation for Test:

1. Fuses OK.
2. Battery voltage >11 V.
3. Unlock vehicle using infrared remote control.
4. Ignition ON.
5. Connect Hand-Held Tester (HHT) to 38-pole data link connector (X11/4) according to connection diagram shown in section 0.

Electrical wiring diagrams :

Electrical Troubleshooting Manual, Model 129, Volume 2, group 80,  
 Model 140, Volume 2, group 80,  
 Model 202, Volume 2, group 80.

Note:

The diagnostic trouble codes (DTC's) can only be read out and erased using the Hand-Held Tester (HHT).

RCL control modules as of part numbers 210 820 21 26 and 210 820 22 26 can be de-synchronized only with the Hand-Held Tester (HHT) (see 11/1).

Special Tools

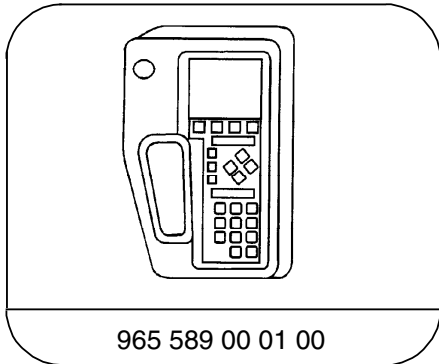

965 589 00 01 00

Hand-Held-Tester

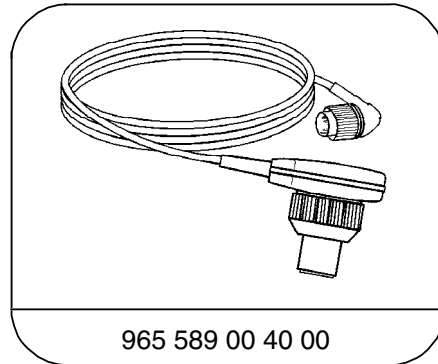

965 589 00 40 00

Test Cable

### Diagnosis – Diagnostic Trouble Code (DTC) Memory

#### Note regarding Diagnostic Trouble Codes (DTC's):

Current diagnostic trouble codes are highlighted in black on the display. Additional detailed fault information based on fault type is displayed with nearly all diagnostic codes (DTC's) such as:

> Ω	Resistance too great
< Ω	Resistance too low
ΓΓ-	Short circuit to ground (GND)
ΓΓ+	Short circuit to positive (POS)
-//-	Open circuit

Additionally, further diagnostic info. such as fault frequency is displayed with some of the diagnostic trouble codes.

#### Fault frequency:

Frequency of the displayed diagnostic trouble code:  
4 = periodic fault, appeared 4 times.

#### Notes regarding the Drive Authorization System (DAS):

- Vehicles equipped with infrared remote central locking (RCL) are also equipped with a Drive Authorization System (DAS).

- The disabling of the engine management system is accomplished via a CAN connection from the RCL control module. Upon disabling the engine management system (vehicle has been locked via RCL), the engine control module interrupts the fuel injection system.
- The drive authorization system (DAS) and anti-theft alarm (ATA) can only be activated or de-activated using either the IR transmitter or the mechanical key.
- The RCL control module and engine control module are “married” together via an identification code. This identification code can not be erased, thus this code remains with the vehicle for its service life. Troubleshooting of an RCL control module (N54) or the engine control module by swapping control modules from another vehicle is no longer possible.



## 4.5 Infrared Remote Central Locking (RCL)

Models 129, 140, 202 as of M.Y. 1996, 210 up to 06/96

### Diagnosis – Diagnostic Trouble Code (DTC) Memory

DTC 	Possible cause	Test step/Remedy <sup>1)</sup>
B1000	RCL control module (N54)	Replace N54
B1100	Control line deactivation, (PSE/CL, CF, ATA), Γ1+ or Γ1-	23 ⇒ 13.0, 14.0, 17.0 – 20.0
B1101	Control line activation, (PSE/CL, CF, ATA), Γ1+ or Γ1-	23 ⇒ 15.0 – 20.0
B1102	Drive Authorization System (DAS) control line, Γ1+ or Γ1-	23 ⇒ 21.0, 22.0
B1103	Red indicator lamp, Γ1+ or Γ1-	23 ⇒ 5.0
B1104	Green indicator lamp, Γ1+ or Γ1-	23 ⇒ 6.0
B1701	Incorrect authorization code, right cylinder bank, (4-6 cylinder) (CAN)	11 ⇒ 6.0
B1702	Incorrect authorization code, left cylinder bank, (8-12 cylinder) (CAN)	11 ⇒ 6.0
B1703	Attempt was made to start vehicle locked via RCL	11 ⇒ 6.0, erase DTC memory

<sup>1)</sup> Observe Preparation for Test, see 22.

Electrical Test Program – Component Locations

Model 202 with HFM sequential multiport fuel injection/ignition (HFM-SFI)

Locations for models 129 and 140 are similar, see below.

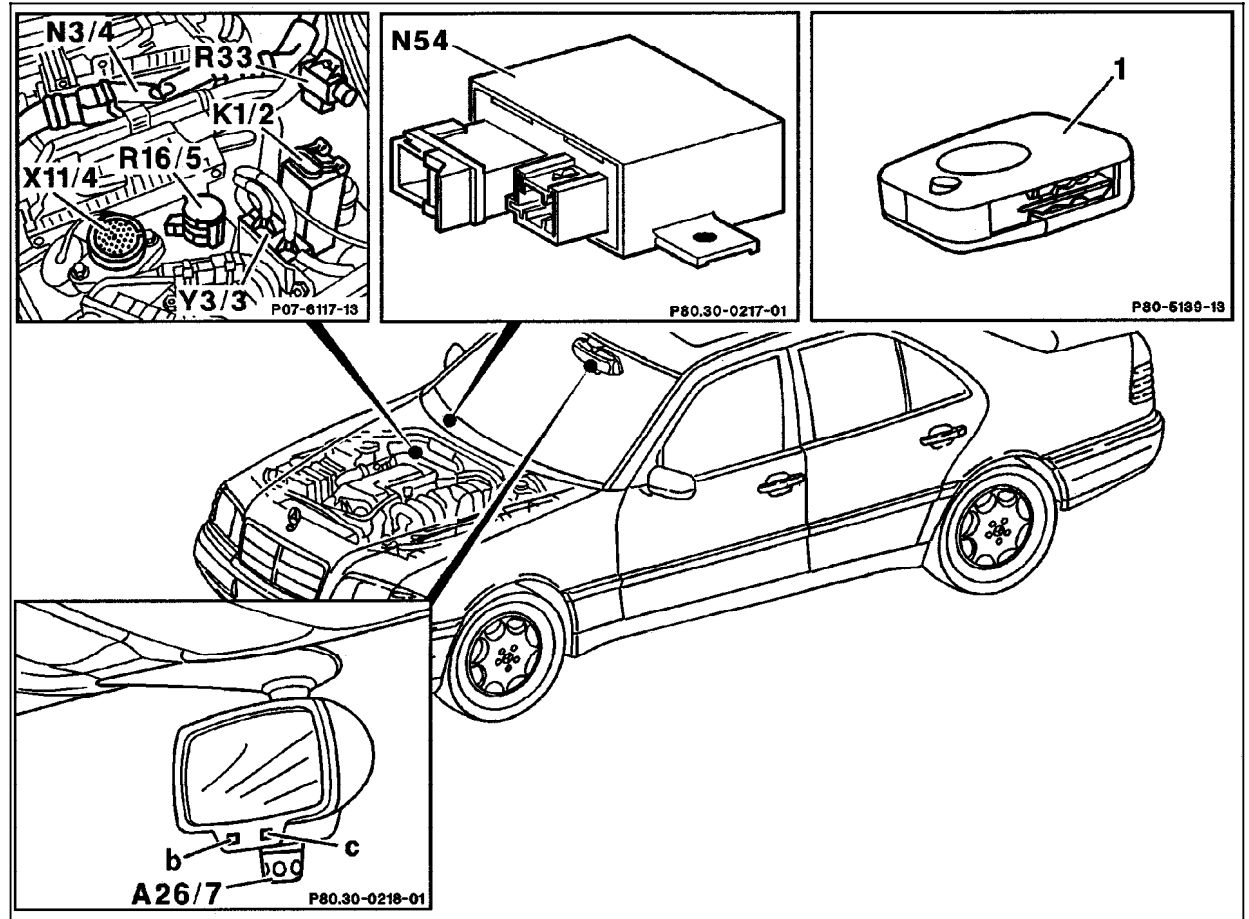

Figure 1

- 1 IR transmitter
- A26/7 RCL receiver (interior rearview mirror)
- N3/4 Engine control module (HFM-SFI)
- N54 RCL control module  
(location: models 202, 210 in passenger side foot panel, models 129, 140 behind passenger side airbag)

U80.20-0203-06

Electrical Test Program – Connection of Components

Connection of RCL control module/DAS shut-off valve control module via CAN  
 Models 202/140

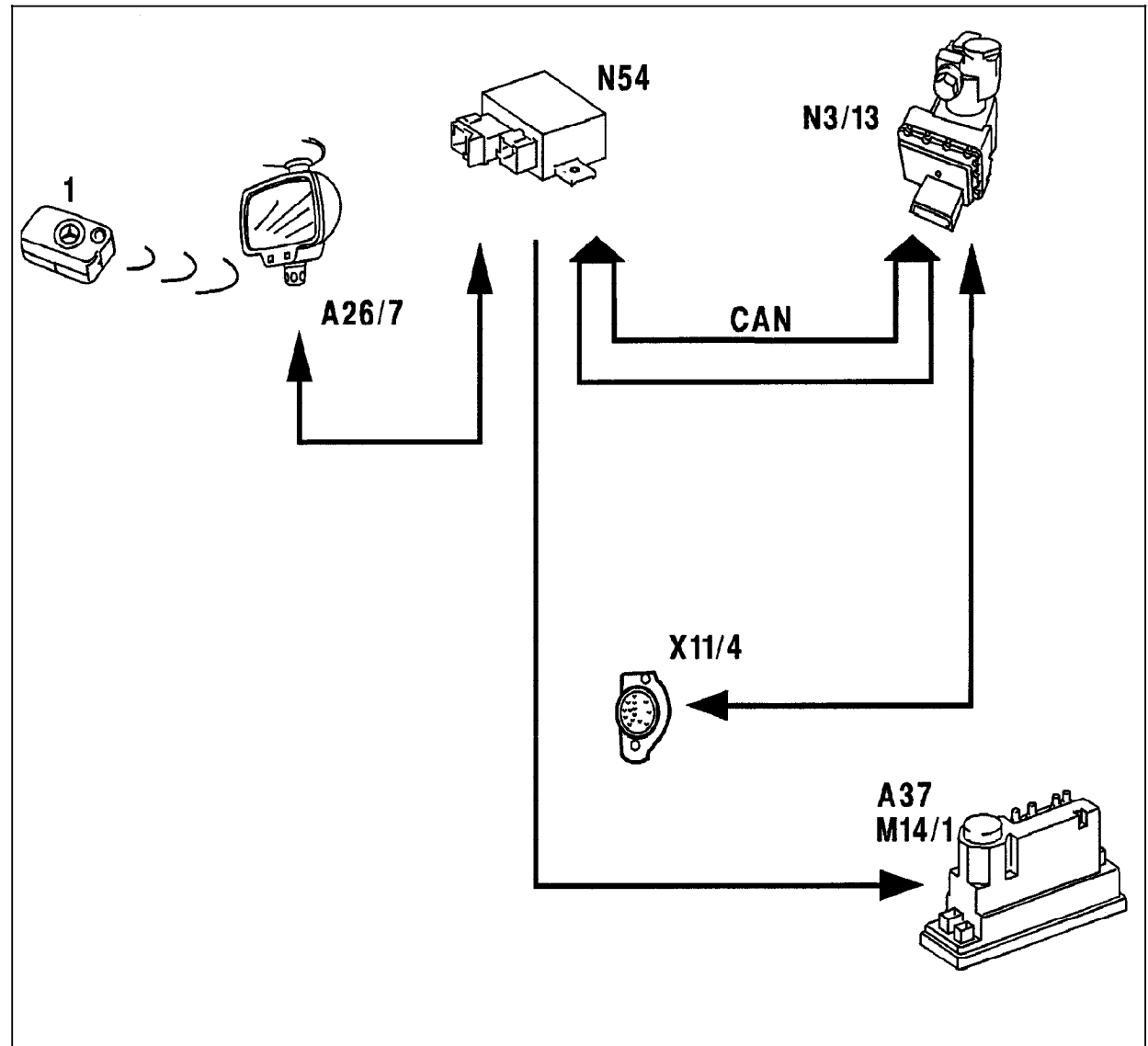

Figure 1

- A26/7 RCL receiver (interior rearview mirror)
- A37 PSE control module, combined functions
- CAN Control-Area-Network
- N3/13 DAS shut-off valve control module
- N54 RCL control module
- X11/4 Data link connector (DTC readout)
- 1 IR transmitter key

U80.30-0245-06

Electrical Test Program – Connection of Components

Connection of RCL control module/Engine control module via CAN  
Models 129/140/202

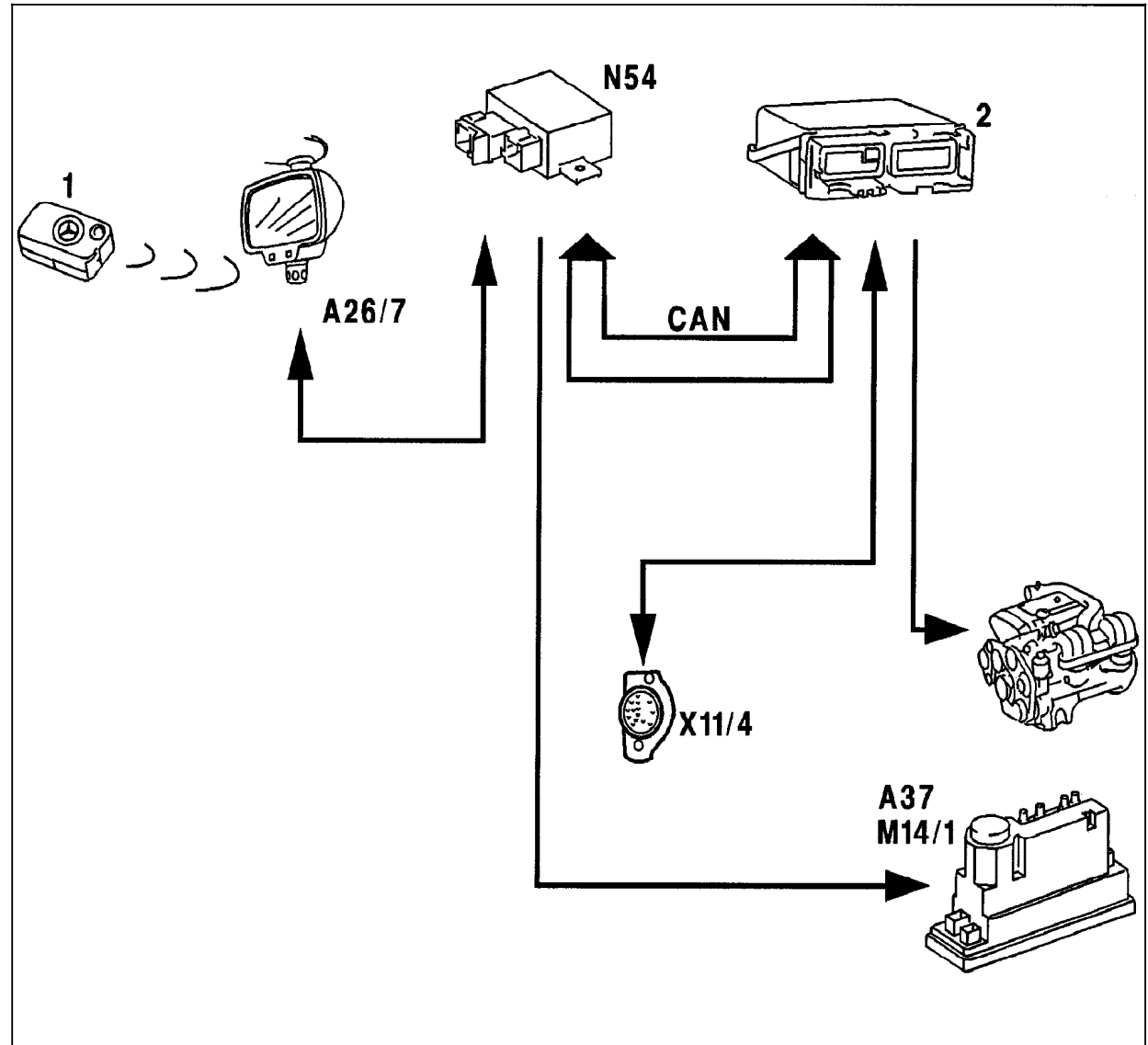

Figure 2

- A26/7 RCL receiver (interior rearview mirror)
- A37 PSE control module, combined functions
- CAN Control-Area-Network
- N54 RCL control module
- M14/1 Supply pump (CL) or Model 129: (CL/vacuum)
- X11/4 Data link connector (DTC readout)
- 1 IR transmitter key
- 2 Engine control module

U80.30-0243-06

Electrical Test Program – Connection of Components

Connection of RCL control module/Engine control module via CAN  
 Model 210

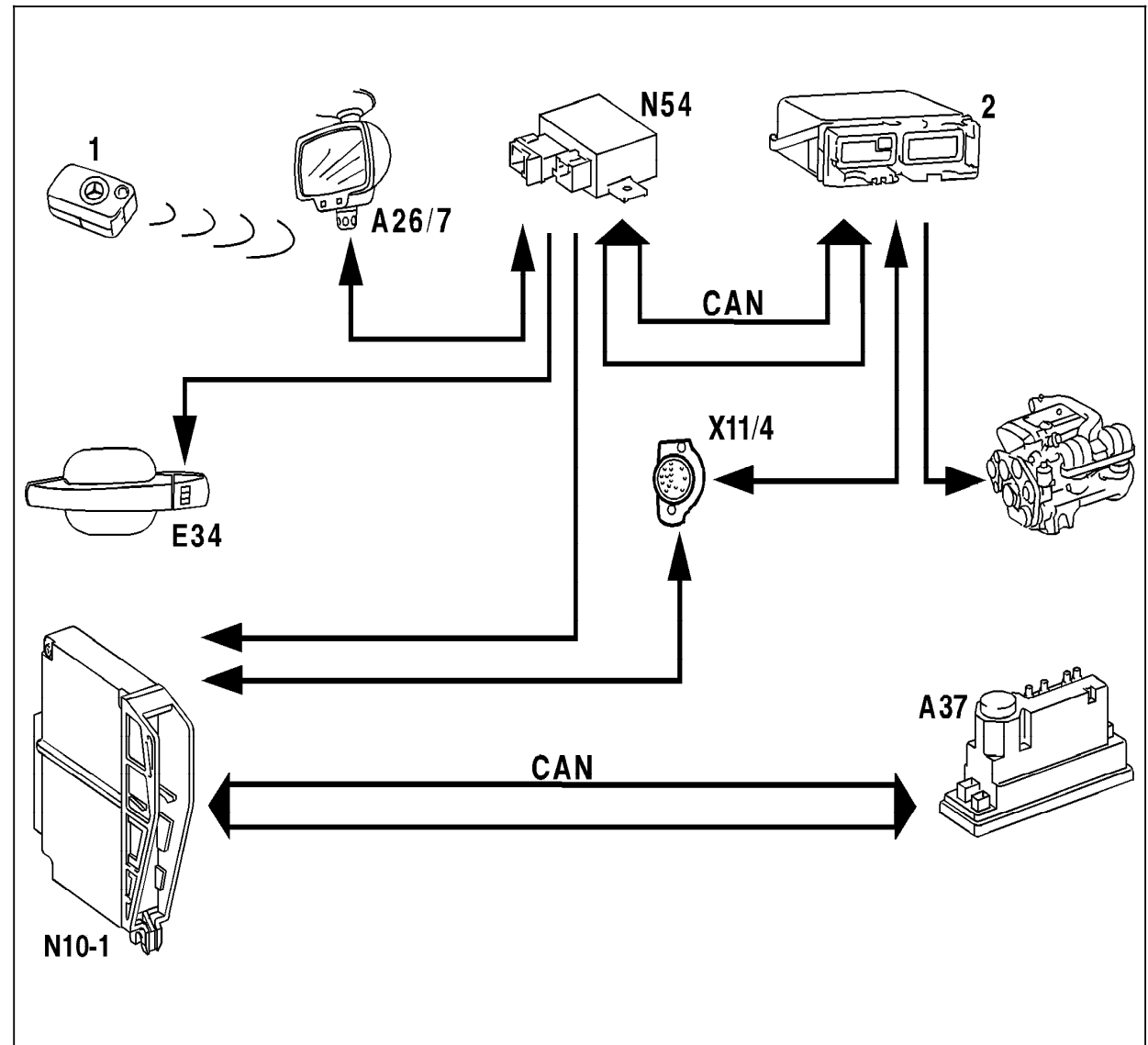

Figure 3

- A26/7 RCL receiver (interior rearview mirror)
- A37 PSE control module, combined functions
- CAN Control-Area-Network
- N10-1 Combination control module
- N54 RCL control module
- X11/4 Data link connector (DTC readout)
- 1 IR transmitter key
- 2 Engine control module

U80.30-0240-06

**Electrical Test Program – Preparation for Test**

Preliminary work:  
 Diagnosis - Diagnostic Trouble Code (DTC) Memory ..... 12

**Preparation for Test:**

1. Fuses OK.
2. Battery voltage >11 V.
3. Install model specific HHT module into HHT.
4. Connect Hand-Held Tester (HHT) to 38-pole data link connector (X11/4) according to connection diagram shown in section 0.

Electrical wiring diagrams :

Electrical Troubleshooting Manual, Model 129, Volume 2, group 80,  
 Model 140, Volume 2, group 80,  
 Model 202, Volume 2, group 80,  
 Model 210, Volume 2, group 80.

**Special Tools**

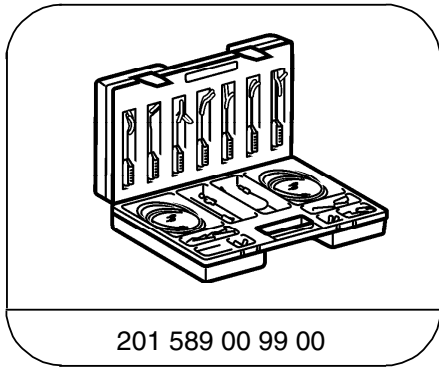

201 589 00 99 00

Electrical connecting set

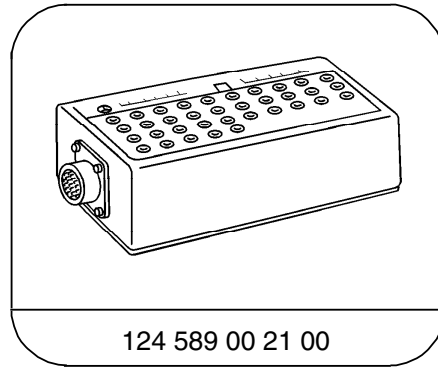

124 589 00 21 00

35-pin socket box

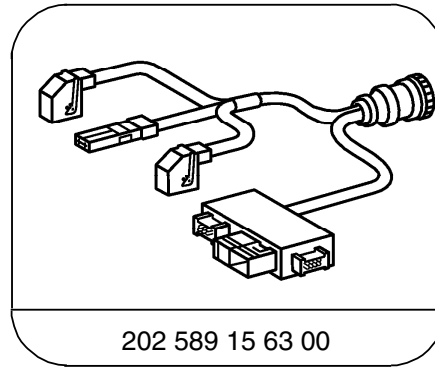

202 589 15 63 00

18-pin and 12-pin CAN test cable

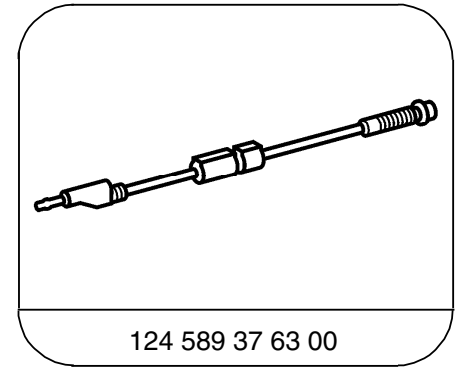

124 589 37 63 00

Fused cable

**Conventional tools, test equipment**

Description	Brand, model, etc.
Multimeter <sup>1)</sup>	Fluke models 23, 83, 85, 87

<sup>1)</sup> Available through the MBUSA Standard Equipment Program.

Electrical Test Program – Test

Connection Diagram - Socket Box

Note:

- Models 129, 140: RCL control module located behind passenger side airbag.
- Models 202, 210: RCL control module located behind passenger side foot panel.

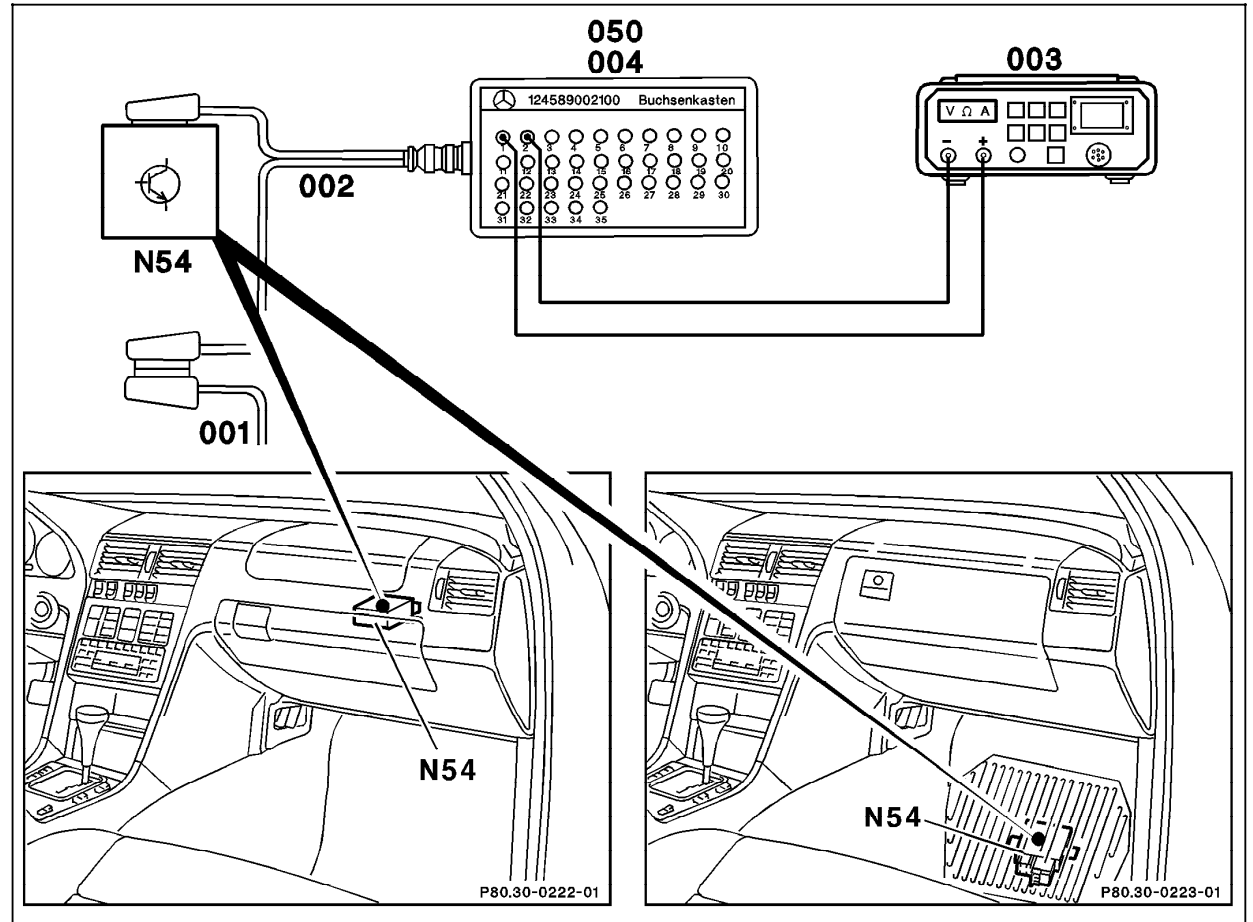

Figure 1













- 001 RCL control module connector
- 002 Test cable
- 003 Multimeter
- 004/050 Socket box (35-pole)
- N54 RCL control module

P80.30-0220-06

## 4.5 Infrared Remote Central Locking (RCL)

Models 129, 140, 202 as of M.Y. 1996, 210 up to 06/96

### Electrical Test Program – Test



⇒		Test scope	Test connection	Test condition	Nominal value	Possible cause/Remedy
1.0		<b>RCL control module (N54)</b> Voltage supply  Circuit 		Ignition: <b>ON</b>	√  F	Wiring, Battery.
2.0		<b>RCL control module (N54)</b> Voltage supply Circuit 15	 1 —  — 9	Ignition: <b>OFF</b>  Ignition: <b>ON</b>	< 1 V  11 – 14 V	Wiring, Circuit 31, ⇒ 2.1
2.1		Circuit 15	 —  — 9 	Ignition: <b>OFF</b>  Ignition: <b>ON</b>	< 1 V  11 – 14 V	Wiring.  Circuit 15.
3.0		<b>RCL receiver (interior rear view mirror) (A26/7)</b> Voltage supply	 2 —  — 11	—	4.5 – 5.5 V	Wiring, A26/7, N54, ⇒ 3.1
3.1		(A26/7) Voltage supply	 7 —  — 8	Remove A26/7.	4.5 – 5.5 V	Wiring, N54



## 4.5 Infrared Remote Central Locking (RCL)

Models 129, 140, 202 as of M.Y. 1996, 210 up to 06/96

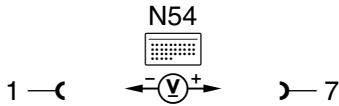
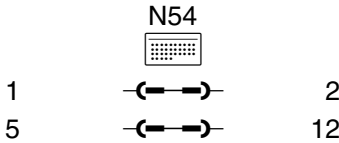

### Electrical Test Program – Test

⇒		Test scope	Test connection	Test condition	Nominal value	Possible cause/Remedy
4.0		<b>RCL receiver (interior rear view mirror) (A26/7)</b> IR signal control line		Lock vehicle by pointing IR transmitter at RCL receiver (interior rear view mirror), keep IR transmitter button pressed. After vehicle completes locking process, read value. Afterwards, release button and read second value.	Difference of values between button depressed and button released approx. 0.3 – 1.0 V	Wiring, A26/7, IR transmitter.
5.0	81103	<b>RCL receiver (interior rear-view mirror) (A26/7), IRCL function indicator (E34)</b> Red indicator lamps		Disconnect N54 from  . No or only 1 bridge (part no. 124 589 37 63 00) connected.  Both bridges connected.	Red indicator lamps off.  Red indicator lamps light.	Wiring, A26/7, E34

## 4.5 Infrared Remote Central Locking (RCL)

Models 129, 140, 202 as of M.Y. 1996, 210 up to 06/96

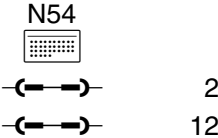
### Electrical Test Program – Test

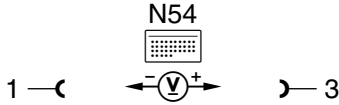
⇒		Test scope	Test connection	Test condition	Nominal value	Possible cause/Remedy
6.0	81104	<b>RCL receiver (interior rear-view mirror) (A26/7), RCL function indicator (E34)</b> Green indicator lamps		Disconnect N54 from  No or only 1 bridge (part no. 124 589 37 63 00) connected.  Both bridges connected.	Green indicator lamps off.  Green indicator lamps light.	Wiring, A26/7, E34
7.0		<b>RCL control module (N54), output deactivation</b> (PSE/CL, CF, ATA) (models 140, 202 only)		All doors are closed and <b>locked</b> .  <b>Unlock</b> vehicle by pointing IR transmitter at RCL receiver (interior rearview mirror), while keeping IR transmitter button pressed.	11 – 14 V  < 1 V Green indicator lamps blink, Vehicle unlocks.	Wiring, N54, PSE control module (A37–A37/5), Power soft top control module (N52), CF control module (N57), ATA control module (N26).  Wiring, ⇒ 3.0, 4.0, 6.0, N54

## 4.5 Infrared Remote Central Locking (RCL)

Models 129, 140, 202 as of M.Y. 1996, 210 up to 06/96

### Electrical Test Program – Test

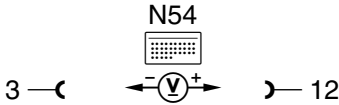
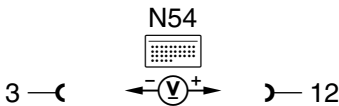
⇒		Test scope	Test connection	Test condition	Nominal value	Possible cause/Remedy
8.0		<b>RCL control module (N54), output deactivation</b> (PSE/CL, CF, ATA) (model 210 only)		<p>All doors closed and <b>locked</b>.</p> <p><b>Unlock</b> vehicle by pointing IR transmitter at RCL receiver (interior rearview mirror), while keeping IR transmitter button pressed.</p>	<p>&lt; 1 V</p> <p>6 – 8 V Green indicator lamps blink, Vehicle unlocks.</p>	<p>Wiring, N54, Combination control module (N10-1).</p> <p>Wiring, ⇒ 3.0 – 5.0, N54</p>
9.0		<b>RCL control module (N54), output activation</b> (PSE/CL) (model 210 only)		<p>All doors closed and <b>unlocked</b>.</p> <p><b>Lock</b> vehicle by pointing IR transmitter at RCL receiver (interior rearview mirror), while keeping IR transmitter button pressed.</p>	<p>&lt; 1 V</p> <p>11 – 14 V, Vehicle locks, red indicator lamps blink,</p>	<p>Wiring, N54, Combination control module (N10-1).</p> <p>Wiring, ⇒ 3.0 – 5.0, N54</p>

## 4.5 Infrared Remote Central Locking (RCL)

Models 129, 140, 202 as of M.Y. 1996, 210 up to 06/96



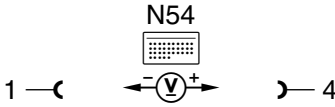
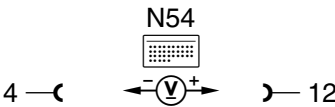

### Electrical Test Program – Test

⇒		Test scope	Test connection	Test condition	Nominal value	Possible cause/Remedy
10.0		<b>RCL control module (N54), output deactivation</b> (PSE/CL) (models 140, 202 only)		All doors closed and <b>unlocked</b> .  <b>Lock</b> vehicle by pointing IR transmitter at RCL receiver (interior rearview mirror), while keeping IR transmitter button pressed.	11 – 14 V  < 1 V Vehicle locks, red indicator lamps blink.	Wiring, N54, PSE (A37–A37/5), CF control module (N57), ATA control module (N26).  Wiring, ⇒ 3.0 – 5.0, N54
11.0		<b>RCL control module (N54), output activation</b> (PSE/CL) (model 129 only)		All doors closed and <b>unlocked</b> .  <b>Lock</b> vehicle by pointing IR transmitter at RCL receiver (interior rearview mirror)	Vehicle locks, red indicator lamps blink, 11 – 14 V for approx. 0.6 sec. (values measurable by using Fluke 83, 88).	Wiring, ⇒ 3.0 – 5.0, N54, PSE (M14/2 [model 129]), N52, N57, N26

## 4.5 Infrared Remote Central Locking (RCL)

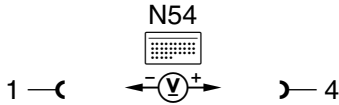
Models 129, 140, 202 as of M.Y. 1996, 210 up to 06/96

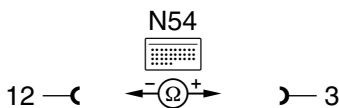















### Electrical Test Program – Test

⇒		Test scope	Test connection	Test condition	Nominal value	Possible cause/Remedy
12.0		<b>RCL control module (N54), output deactivation</b> PSE/CL (model 129 only)		<p>All doors closed and <b>locked</b>. <b>Disconnect supply pump (M14/2).</b></p> <p><b>Unlock</b> vehicle by pointing IR transmitter at RCL receiver (interior rearview mirror).</p>	<p>Green indicator lamps blink. 11 – 14 V for approx. 0.6 seconds. (values measurable by using Fluke 83, 88).</p>	<p>Wiring, ⇒ 3.0, 4.0, 6.0, N54</p>
13.0		<b>Control line deactivation</b> (PSE/CL, CF, ATA) Γ1+ (models 129, 140, 202 only)		<p>Disconnect N54 from .</p> <p>Disconnect PSE (M14/2, or A37–A37/5).</p> <p>Disconnect ground wire from .</p> <p>Model 129 only: disconnect N52, N26.</p>	>20 kΩ	Wiring.

## 4.5 Infrared Remote Central Locking (RCL)

Models 129, 140, 202 as of M.Y. 1996, 210 up to 06/96







### Electrical Test Program – Test

⇒		Test scope	Test connection	Test condition	Nominal value	Possible cause/Remedy
14.0		<b>Control line deactivation (PSE/CL, CF, ATA)</b> Γ1- (models 129, 140, 202 only)		Disconnect N54 from  Disconnect PSE (M14/2, or A37–A37/5). Disconnect ground wire from  Model 129 only: disconnect N52, N26.	>20 kΩ	Wiring.
15.0		<b>Control line activation (PSE/CL, CF, ATA)</b> Γ1+ (models 140, 202 only)		Disconnect N54 from  Disconnect PSE ( A37–A37/5). Disconnect ground wire from 	>20 kΩ	Wiring.
16.0		<b>Control line activation (PSE/CL, CF, ATA)</b> Γ1- (models 140, 202 only)		Disconnect N54 from  Disconnect PSE (A37–A37/5).	>20 kΩ	Wiring.
17.0		<b>Control line deactivation/activation (PSE/CL)</b> Γ1+ (model 129 only)		Disconnect N54 from  Disconnect PSE (M14/2). Disconnect ground wire from 	>20 kΩ	Wiring.

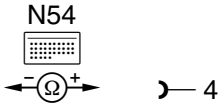
## 4.5 Infrared Remote Central Locking (RCL)

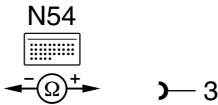
Models 129, 140, 202 as of M.Y. 1996, 210 up to 06/96

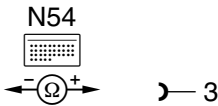



### Electrical Test Program – Test

⇒		Test scope	Test connection	Test condition	Nominal value	Possible cause/Remedy
18.0	B1100 B1101	<b>Control line deactivation/activation (PSE/CL)</b> Γ1- (model 129 only)		Disconnect N54 from  Disconnect PSE (M14/2).	>20 kΩ	Wiring.
19.0	B1100 B1101	<b>Control line deactivation/activation (PSE/CL, CF, ATA)</b> Γ1+ (model 210 only)		Disconnect N54 from  Disconnect combination control module (N10-1). Disconnect ground wire from  .	>20 kΩ	Wiring.
20.0	B1100 B1101	<b>Control line deactivation/activation (PSE/CL, CF, ATA)</b> Γ1- (model 210 only)		Disconnect N54 from  Disconnect combination control module (N10-1).	>20 kΩ	Wiring.
21.0	B1102	<i>Non-USA vehicles only, continue to next test step.</i>	- - -	-	-	-
22.0	B1102	<i>Non-USA vehicles only, continue to next test step.</i>	- - -	-	-	-
23.0		<i>Non-USA vehicles only, continue to next test step.</i>	- - -	-	-	-

## 4.5 Infrared Remote Central Locking (RCL)

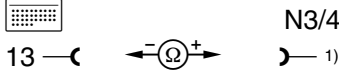
Models 129, 140, 202 as of M.Y. 1996, 210 up to 06/96

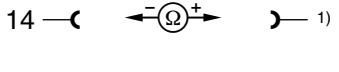
### Electrical Test Program – Test

⇒		Test scope	Test connection	Test condition	Nominal value	Possible cause/Remedy
24.0		<b>CAN L data line</b> Motor electronics activation -//- (CAN only)	N54 	Disconnect N54 from  Disconnect N3/4 (HFM-SFI) or N3/7 (IFI), N3/10, N3/11, N3/12, (ME-SFI) or N3/13 (DAS) control module.	<1 Ω	Wiring.
25.0		<b>CAN H data line</b> Motor electronics activation -//- (CAN only)	N54 	Disconnect N54 from  Disconnect N3/4 (HFM-SFI) or N3/7 (IFI), N3/10, N3/11, N3/12, (ME-SFI) or N3/13 (DAS) control module.	<1 Ω	Wiring.







1) Prior to testing, please see appropriate ETM (group 7) to determine control module harness socket number.

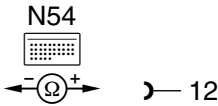

## 4.5 Infrared Remote Central Locking (RCL)

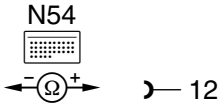
Models 129, 140, 202 as of M.Y. 1996, 210 up to 06/96

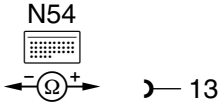



### Electrical Test Program – Test

⇒		Test scope	Test connection	Test condition	Nominal value	Possible cause/Remedy
26.0		<b>CAN L data line</b> Motor electronics activation Γ1+ (CAN only)		Disconnect N54 from  . Disconnect ground wire from  . Disconnect N3/4 (HFM-SFI) or N3/7 (IFI), N3/10, N3/11, N3/12, (ME-SFI) or N3/13 (DAS) control modules.	>20 kΩ	Wiring.
27.0		<b>CAN H data line</b> Motor electronics activation Γ1+ (CAN only)		Disconnect N54 from  . Disconnect ground wire from  . Disconnect N3/4 (HFM-SFI) or N3/7 (IFI), N3/10, N3/11, N3/12, (ME-SFI) or N3/13 (DAS) control modules.	>20 kΩ	Wiring.
28.0		<b>CAN L data line</b> Motor electronics activation Γ1- (CAN only)		Disconnect N54 from  . Disconnect N3/4 (HFM-SFI) or N3/7 (IFI), N3/10, N3/11, N3/12, (ME-SFI) or N3/13 (DAS) control modules.	>20 kΩ	Wiring.

## 4.5 Infrared Remote Central Locking (RCL)

Models 129, 140, 202 as of M.Y. 1996, 210 up to 06/96

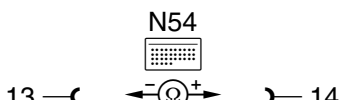

### Electrical Test Program – Test

⇒		Test scope	Test connection	Test condition	Nominal value	Possible cause/Remedy
29.0		<b>CAN H data line</b> Motor electronics activation Γ1- (CAN only)		Disconnect N54 from  . Disconnect N3/4 (HFM-SFI) or N3/7 (IFI), N3/10, N3/11, N3/12, (ME-SFI) or N3/13 (DAS) control modules.	>20 kΩ	Wiring.
30.0		<b>CAN H/CAN L data line</b> Motor electronics activation Γ1 to each other (CAN only)		Disconnect N54 from  . Disconnect N3/4 (HFM-SFI) or N3/7 (IFI), N3/10, N3/11, N3/12, (ME-SFI) or N3/13 (DAS) control modules.	>20 kΩ	Wiring.
31.0		<b>Non-USA vehicles only.</b> <b>Continue to next test step.</b>				

## 4.5 Infrared Remote Central Locking (RCL)

Models 129, 140, 202 as of M.Y. 1996, 210 up to 06/96

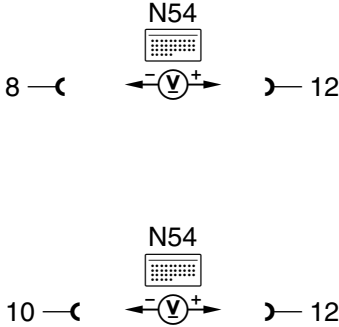

### Electrical Test Program – Test

⇒		Test scope	Test connection	Test condition	Nominal value	Possible cause/Remedy
32.0		<b>Left front door lock switch (S86/1)</b>		Disconnect N54 from  . Disconnect trunk lid lock switch (S88/2).  S86/1: <b>Rest position</b>  S86/1: <b>Hold: unlock</b>  S86/1: <b>Rest position</b>  S86/1: <b>Hold: lock</b>	   < 1 V  11 – 14 V  < 1 V  11 – 14 V	Wiring, S86/1

## 4.5 Infrared Remote Central Locking (RCL)

Models 129, 140, 202 as of M.Y. 1996, 210 up to 06/96

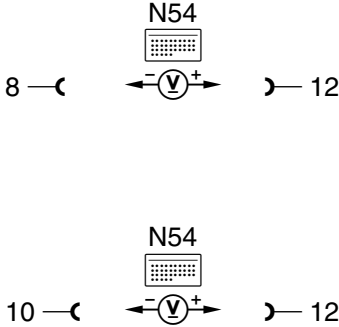
### Electrical Test Program – Test

⇒		Test scope	Test connection	Test condition	Nominal value	Possible cause/Remedy
33.0		<b>Trunk lid lock switch (S88/2) (CF)</b>		Disconnect N54 from  Separate left front door separation point (X35/1).  S88/2: <b>Rest position</b>  S88/2: <b>Hold: unlock</b>  S88/2: <b>Rest position</b>  S88/2: <b>Hold: lock</b>	   < 1 V  11 – 14 V  < 1 V  11 – 14 V	Wiring, S88/2

**Version Coding and Programming****Version coding**

- For universal control modules which must be coded, menu item 7 appears on the HHT's display. These control modules must be coded accordingly. The version coding is menu-driven.

**Possible version coding**

Version	Model 129	Model 140	Model 202	Model 210
Vehicle version	X	X	X	X
Convenience Feature (CF)	X	X	X	X
Remote trunk lid release (RTR)		X		X
Lock switch verification	X	X	X	X

**Programming**

- For universal control modules which must be programmed with the locking code, menu item 8 appears on the HHT's display. These control modules must be programmed accordingly. The programming is menu-driven.
- Programming must be performed using an original IR transmitter (key).