

6.1 Model 129 (CFI only)

	Page
Diagnosis	
Complaint Related Diagnostic Chart	11/1
Electrical Test Program	
Component Locations	21/1
Preparation for Test	22/1
Test	23/1

Diagnosis - Complaint Related Diagnostic Chart

Complaint/Problem	Possible cause	Test step/Remedy ¹⁾
With light brake pedal applications, the brake pedal pulsates shortly before the vehicle comes to a stop.	Voltage at vehicle speed sensor too low, vehicle speed sensor cable has intermittently open circuit	23 ⇒ 8.0-13.0, 17.0, 20.0, 23.0 ¹⁾
ABS malfunction indicator lamp comes on and stays on while driving	Speed sensor wire interrupted	23 ⇒ 8.0-13.0, 17.0, 20.0, 23.0 ¹⁾
ABS malfunction indicator lamp comes on and goes out again while driving	Battery voltage < 11 V, too many electrical consumers in operation, poor ground	23 ⇒ 3.0
ABS malfunction indicator lamp is on, charge indicator lamp is off	Generator defective (1 diode)	Test generator
ABS malfunction indicator lamp and charge indicator lamp are on	Generator defective (2 diodes)	Test generator
ABS malfunction indicator lamp does not go out when engine is started	ABS control module (N30) connector not connected Poor contacts in control module connector Overvoltage protection relay module defective, fuse blown	23 ⇒ 1.0, 3.0
ABS malfunction indicator lamp does not light up with ignition on	Diode in solenoid valve relay defective, bulb defective	23 ⇒ 7.0
Return/pressure pump motor with ignition key removed	Return/pressure pump rely (A7k2) stuck closed	Check return/pressure pump relay (A7k2)
ABS malfunction indicator lamp comes on at higher speeds (approx. 35 mph) and stays on	Rear axle vehicle speed sensor or toothed wheel defective or damaged	23 ⇒ 12.0, 13.0, 23.0

¹⁾ Observe Preparation for Test, see 22.

Electrical Test Program - Component Locations

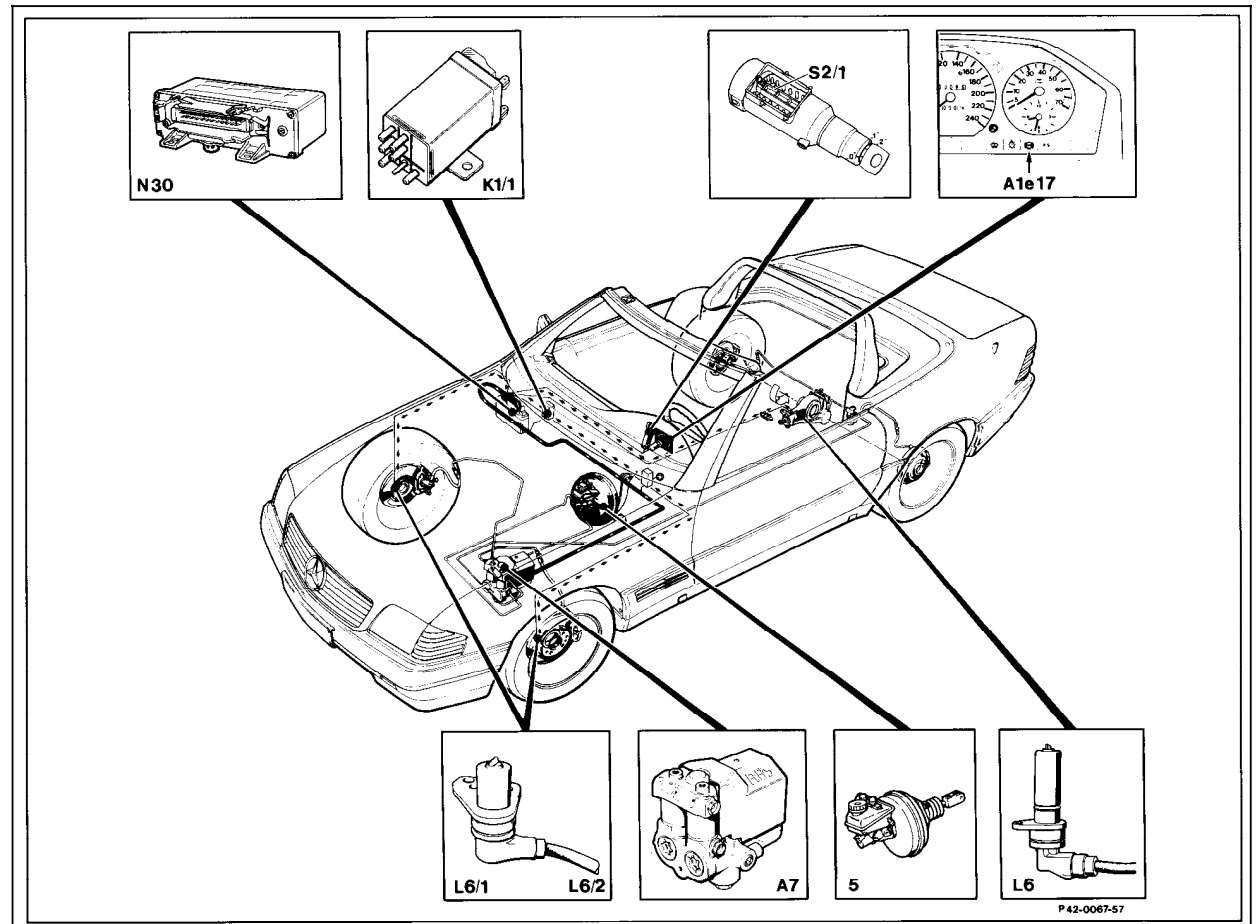



Figure 1

- 5 Brake booster with tandem master brake cylinder
- A1e17 ABS malfunction indicator lamp
- A7 ABS hydraulic unit
- K1/1 Overvoltage protection relay module (87E, 7-pole)
- L6 Rear axle vehicle speed sensor
- L6/1 Left front axle vehicle speed sensor
- L6/2 Right front axle vehicle speed sensor
- N30 ABS control module
- S2/1 Ignition/starter switch

P42-0067-57

Electrical Test Program - Preparation for Test

- For all test steps performed with ignition **ON**, the LED  must light up, i.e. battery voltage O.K.
- When testing , all other electrical consumers must be turned off.
- For ⇒ 23.0 - 25.0 the rear wheels must be raised off the ground.

Note:

Unscrew locking tab (arrow, 23 Fig. 13) from ABS-adapter plug 126 589 09 21 00.

Note:

The entire ABS test must be performed after any repairs or other work on either the ABS system or the brake system.

Note:

It is assumed that the technician is capable of testing switches, relays, lamps, connectors and wires for proper operation without further instructions.



Never drive the vehicle with the ABS-adapter (07) connected!

Special Tools

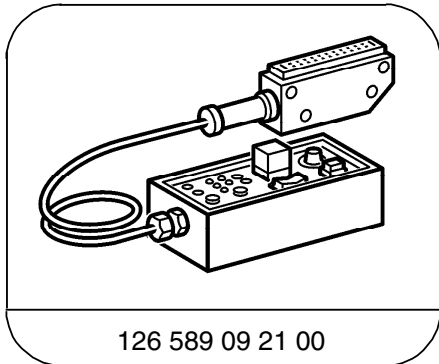

126 589 09 21 00

35-pin socket box

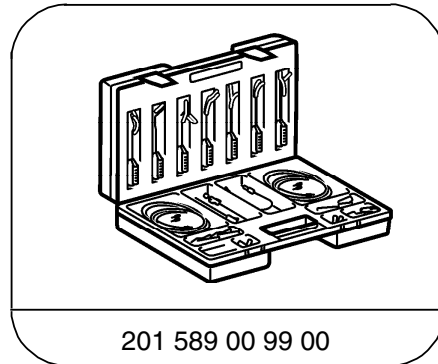

201 589 00 99 00

Electrical connecting set

Equipment

Multimeter ¹⁾	Fluke models 23, 83, 85, 87 SUN DMM-5
--------------------------	--

¹⁾ Available through the MBUSA Standard Equipment Program.

Electrical Test Program - Preparation for Test

Connection Diagram –
Multimeter to ABS-Adaptor



Unplug connector to ABS control module
(N30) with ignition switched **OFF**
(Figure 1)

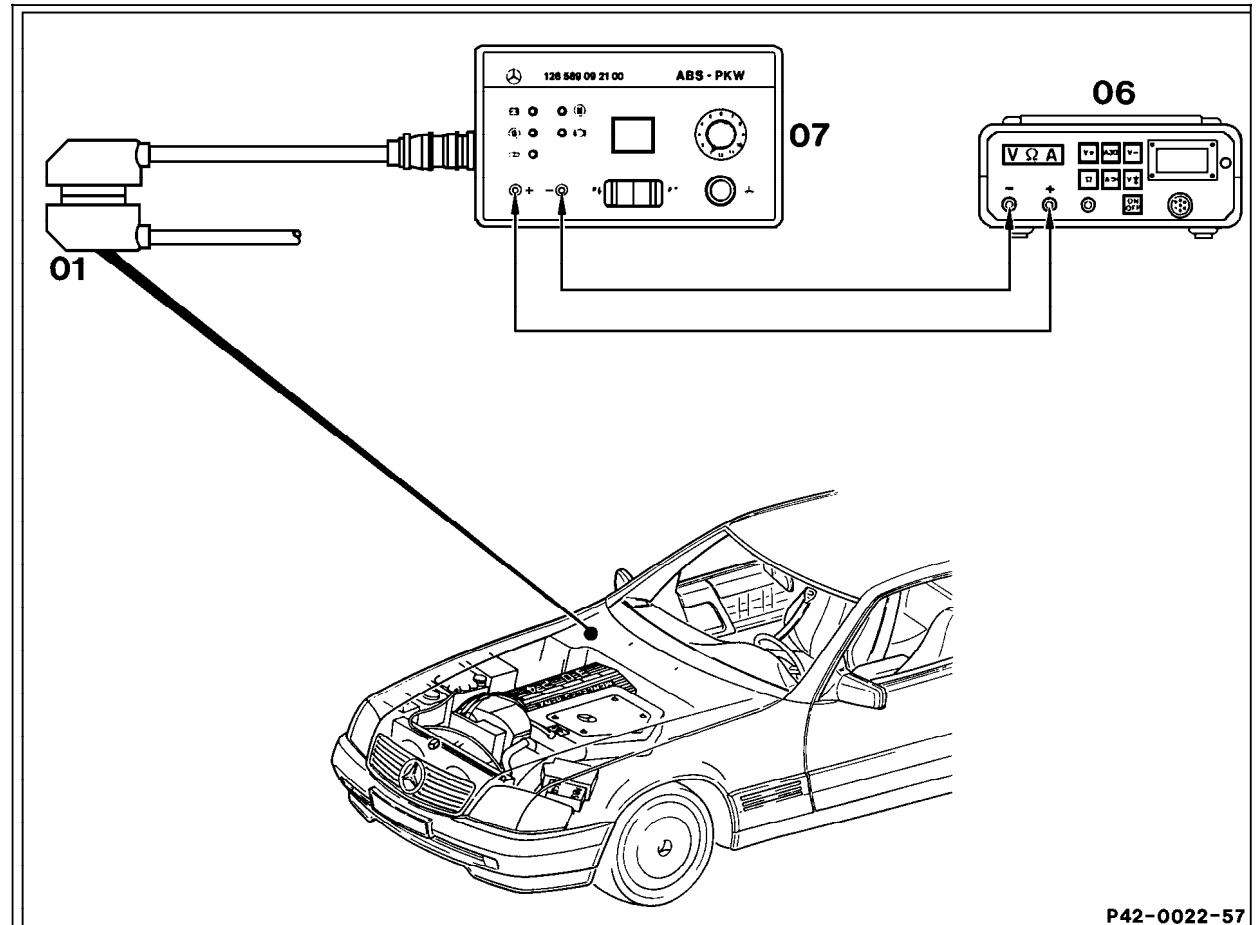







Figure 1



- 01 Vehicle wiring harness (ABS/ASR control module)
- 06 Multimeter
- 07 ABS-adaptor 126 589 09 21 00

P42-0022-57
P42-0022-57











Electrical Test Program - Test

Test step Adaptor position	Test scope	Test connection	Test condition	Nominal value	Possible cause/Remedy
⇒ 1.0	1 Overvoltage protection relay module (87E, 7-pole) (K1/1)	-	Ignition: OFF	LED All: OFF	Check overvoltage protection relay module (K1/1) (Figure 1).
⇒ 2.0	1 Solenoid valve relay (A7k1)	-	Ignition: OFF	LED All: OFF	Check solenoid valve relay (A7k1) (Figure 2).
⇒ 3.0	1 Overvoltage protection relay module (87E, 7-pole) (K1/1)	Connect  to 	Ignition: ON	11 - 14 V LED  : ON  : ON ABS malfunction indicator lamp: ON	Wiring interrupted, Battery not properly charged, Check fuse for overvoltage protection relay module (K1/1), Check ABS malfunction indicator lamp (A1e17), Check solenoid valve relay (A7k1), Check overvoltage protection relay module (K1/1).
⇒ 4.0	1 Generator, circuit 61	-	Engine: RUN BRIEFLY	LED  : OFF	Wiring interrupted, Terminal block (terminal 30/30Ü/61e/87L) (X4/10) poor contact (Figure 4), Generator or generator wiring defective.













Electrical Test Program - Test

Test step Adaptor position	Test scope	Test connection	Test condition	Nominal value	Possible cause/Remedy
⇒ 4.0	1 Stop lamp switch (S9/1)	-	Ignition: ON Depress brake pedal	LED ⊖: ON	Wiring interrupted, check stop lamp switch (S9/1).
⇒ 6.0	2 Solenoid valve relay (A7k1)	-	Ignition: ON	LED ⊕ : ON ⊖ : ON ⊘ : ON Malfunction indicator lamp: OFF	Terminal block (terminal) 30/30U/61e/87L) (X4/10) poor contact (Figure 4), Wiring interrupted, Check solenoid valve relay (A7k1) (Figure 2)
⇒ 7.0	3 Diode in solenoid valve relay (A7k1)	Connect $\leftarrow \text{V} \rightarrow$ to 	Ignition: ON	0.4 - 1.5 V LED ⊕ : ON ⊖ : ON	Check solenoid valve relay (A7k1).
⇒ 8.0	4 Left front axle vehicle speed sensor (L6/1) Internal resistance	Connect $\leftarrow \text{Ω} \rightarrow$ to 	Ignition: ON	0.85 - 2.3 kΩ	Wiring interrupted, Check left front axle vehicle speed sensor (L6/1).







Electrical Test Program - Test

Test step Adaptor position	Test scope	Test connection	Test condition	Nominal value	Possible cause/Remedy
⇒ 9.0	4 Left front axle vehicle speed sensor (L6/1) Insulation resistance	Connect  to 	Ignition: ON Press button: 	> 20 kΩ	Check left front axle vehicle speed sensor (L6/1).
⇒ 10.0	5 Right front axle vehicle speed sensor (L6/2) Internal resistance	Connect  to 	Ignition: ON	0.85 - 2.3 kΩ	Wiring interrupted, Check right front axle vehicle speed sensor (L6/2).
⇒ 11.0	5 Right front axle vehicle speed sensor (L6/2) Insulation resistance	Connect  to 	Ignition: ON Press button: 	> 20 kΩ	Check right front axle vehicle speed sensor (L6/2).
⇒ 12.0	6 Rear axle vehicle speed sensor (L6) Internal resistance	Connect  to 	Ignition: ON	0.6 - 1.6 kΩ	Wiring interrupted, Check rear axle vehicle speed sensor (L6).













Electrical Test Program - Test

Test step Adaptor position	Test scope	Test connection	Test condition	Nominal value	Possible cause/Remedy
⇒ 13.0	6 Rear axle vehicle speed sensor (L6) Insulation resistance	Connect  to 	Ignition: ON Press button: 	> 20 kΩ	Check rear axle vehicle speed sensor (L6).
⇒ 14.0	8 Left front axle solenoid valve (A7y2) Internal resistance	Connect  to 	Ignition: OFF Press button: 	0.7 - 2.2 Ω	Wiring interrupted, Check ABS hydraulic unit (A7).
⇒ 15.0	9 Right front axle solenoid valve (A7y2) Internal resistance	Connect  to 	Ignition: OFF Press button: 	0.7 - 2.2 Ω	Wiring interrupted, Check ABS hydraulic unit (A7).
⇒ 16.0	10 Rear axle solenoid switch (A7y3) Internal resistance	Connect  to 	Ignition: OFF Press button: 	0.7 - 2.2 Ω	Wiring interrupted, Check ABS hydraulic unit (A7).









Electrical Test Program - Test

Test step Adaptor position	Test scope	Test connection	Test condition	Nominal value	Possible cause/Remedy
⇒ 17.0 4	Left front axle speed sensor (L6/1) Voltage	Connect  to 	Raise vehicle Ignition: ON Turn wheel at approximately one revolution/second.	≥ 0.1 V~	Open circuit or wires connected incorrectly, Excessive wheel bearing play, Check left front axle vehicle speed sensor (L6/1).
⇒ 18.0 8	Left front axle solenoid valve (A7y1) Pressure retention	 remains connected	Vehicle raised Ignition: ON Turn wheel at approximately one revolution/second . Press switch: “ P= ”. Depress brake pedal.	LED  : ON  : ON  : ON  : ON Wheel must be able to rotate.	Ground (ABS hydraulic unit bracket) (W14) poor contact (Figure 10), Brake lines on ABS hydraulic unit (A7) reversed, Wires reversed, Check ABS hydraulic unit (A7).











Electrical Test Program - Test

Test step Adaptor position	Test scope	Test connection	Test condition	Nominal value	Possible cause/Remedy
⇒ 19.0	8 Left front axle solenoid valve (A7y1) Pressure reduction	 remains connected	Vehicle raised Ignition: ON Depress brake pedal. Press switch: “ P ”. Turn wheel at approximately one revolution/second	LED  : ON  : ON  : ON  : ON  : ON Wheel must be able to rotate.	Ground (ABS hydraulic unit bracket) (W14) poor contact (Figure 10), Check return/pressure pump relay (A7k2) (Figure 2), Check ABS hydraulic unit (A7)
⇒ 20.0	5 Right front axle speed sensor (L6/2) Voltage	Connect  to 	Raise vehicle Ignition: ON Turn wheel at approximately one revolution/speed	≥ 0.1 V~	Open circuit or wires connected incorrectly, Excessive wheel bearing play, Check right front wheel speed sensor (L6/2).
⇒ 21.0	9 Right front axle solenoid valve (A7y2) Pressure retention	 remains connected	Vehicle raised Ignition: ON Turn wheel at approximately one revolution/second . Press switch: “ P= ”. Depress brake pedal.	LED  : ON  : ON  : ON  : ON Wheel must be able to rotate.	Wires connected incorrectly, Ground (ABS hydraulic unit bracket) (W14) poor contact (Figure 10), Check ABS hydraulic unit (A7).

Electrical Test Program - Test

Test step Adaptor position	Test scope	Test connection	Test condition	Nominal value	Possible cause/Remedy
⇒ 22.0	9 Right front axle solenoid valve (A7y2) Pressure reduction	 remains connected	Vehicle raised Ignition: ON Twice depress brake pedal. Press switch: “ P ”. Turn wheel at approximately one revolution/second .	LED  : ON  : ON  : ON  : ON  : ON Wheel must be able to rotate.	Ground (ABS hydraulic unit bracket) (W14) poor contact (Figure 10), Check return/pressure pump relay (A7k2) (Figure 2), Check ABS hydraulic unit (A7)
⇒ 23.0	6 Rear axle vehicle speed sensor (L6) Voltage	Connect  to 	Raise vehicle Ignition: ON Turn wheel at approximately one revolution/second.	≥ 0.1 V~	Wires interrupted, Rear axle vehicle speed sensor dirty, Check rear axle vehicle speed sensor (L6).

Electrical Test Program - Test

Test step Adaptor position	Test scope	Test connection	Test condition	Nominal value	Possible cause/Remedy
⇒ 24.0 10	Rear Axle solenoid valve (A7y3) Pressure retention	 remains connected	Vehicle raised Ignition: ON Turn wheel at approximately one revolution/second. Press switch: " P= ". Depress brake pedal.	LED  : ON  : ON  : ON  : ON Wheel must be able to rotate.	Wire connected incorrectly, Ground (ABS hydraulic unit bracket) (W14) poor contact (Figure 10), Brake lines on hydraulic unit interchanged, Check ABS hydraulic unit (A7).
⇒ 25.0 10	Left rear axle solenoid valve (A7/3y3) Pressure reduction	 remains connected	Vehicle raised Ignition: ON Apply brake pedal. Press switch: " P ". Turn wheel at approximately one revolution/second.	LED  : ON  : ON  : ON  : ON  : ON Wheel must be able to rotate.	Ground (ABS hydraulic unit bracket) (W14) poor contact (Figure 10), Return/pressure pump relay (A7k2) (Figure 2), ABS/ASR hydraulic unit (A7/3).

Electrical Test Program - Test

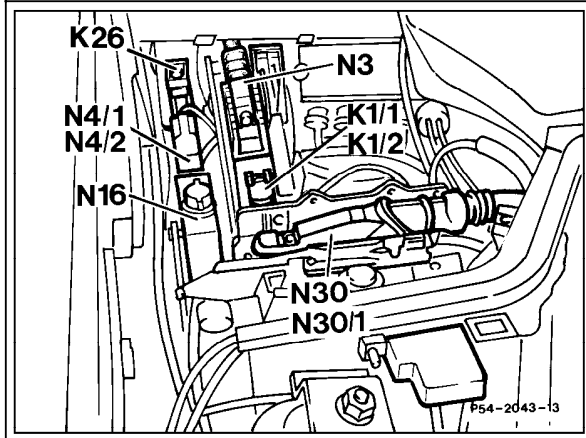

P54-2043-13

Figure 1

- K1/1 Overvoltage protection relay module (87E, 7-pole)
- N30 ABS control module

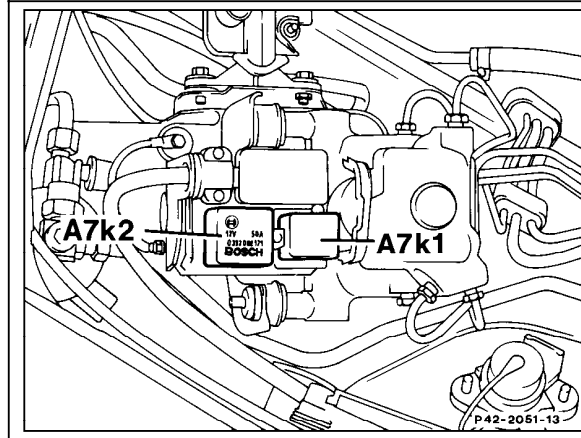

P42-2051-13

Figure 2

- A7k1 Solenoid valve relay
- A7k2 Return/pressure pump relay

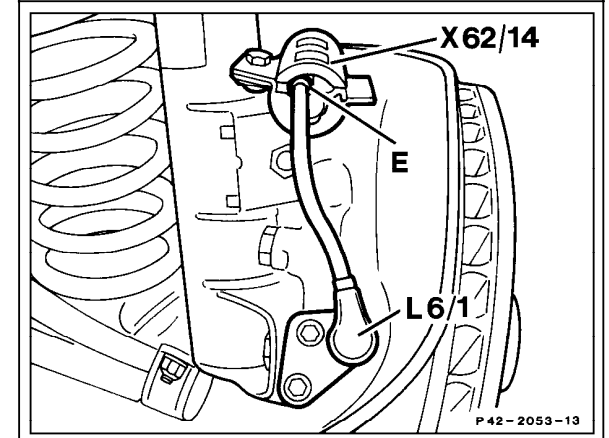

P42-2053-13

Figure 3

- L6/1 Left front axle vehicle speed sensor
- X62/14 Left front axle vehicle speed sensor connector (axle spindle)

Electrical Test Program - Test

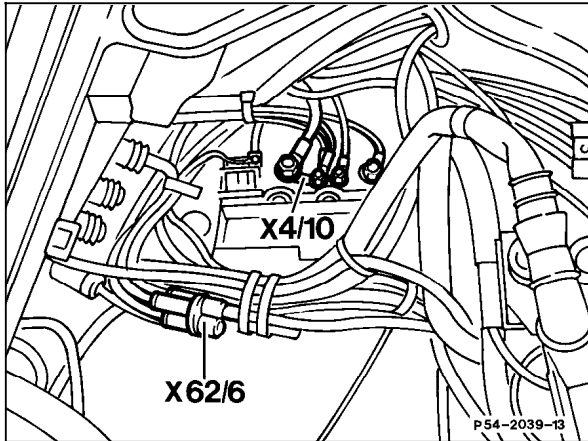

P54-2039-13

Figure 4

X4/10 Terminal block (terminal 30/30Ue/61e/87L)
 X62/6 Right front axle vehicle speed sensor connector
 (Component Compartment)

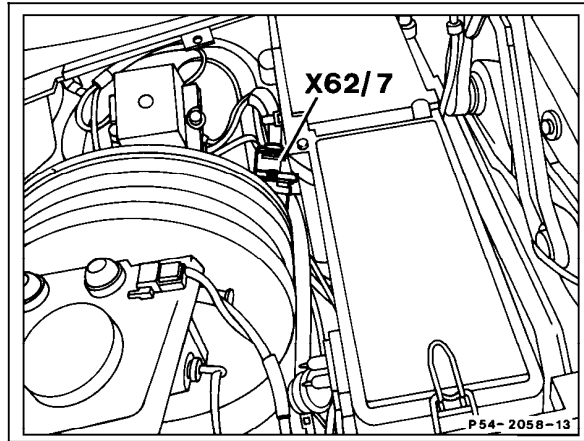

P54-2058-13

Figure 5

X62/7 Left front axle vehicle speed sensor connector
 (component compartment)

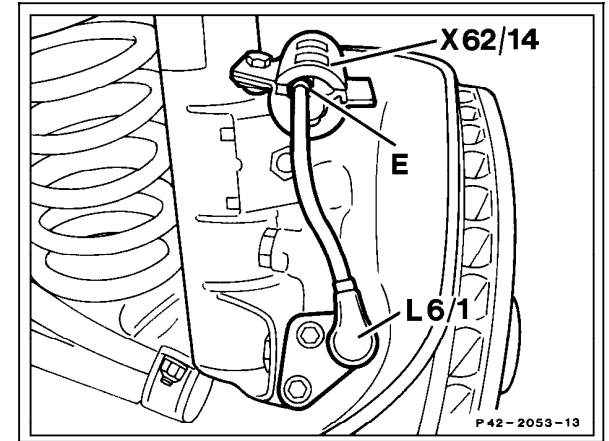

P42-2053-13

Figure 6

X62/14 Left front axle vehicle speed sensor connector
 (axle spindle)

Electrical Test Program - Test

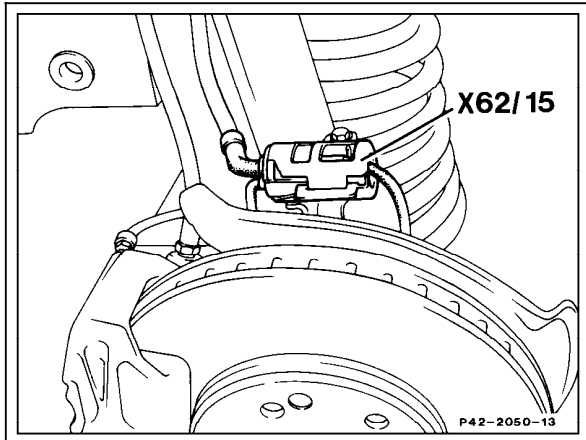

P42-2050-13

Figure 7

X62/15 Right spindle axle vehicle speed sensor connector (axle spindle)

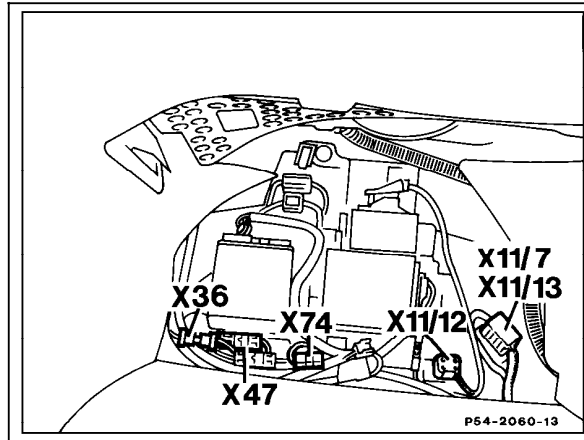

P54-2060-13

Figure 8

X47 Rear axle vehicle speed sensor harness connector (2-pole)

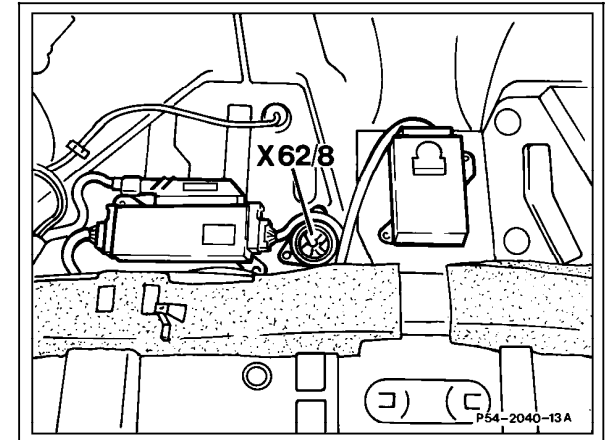

P54-2040-13A

Figure 9

X62/8 Rear axle multiple circuit junction connector

Electrical Test Program - Test

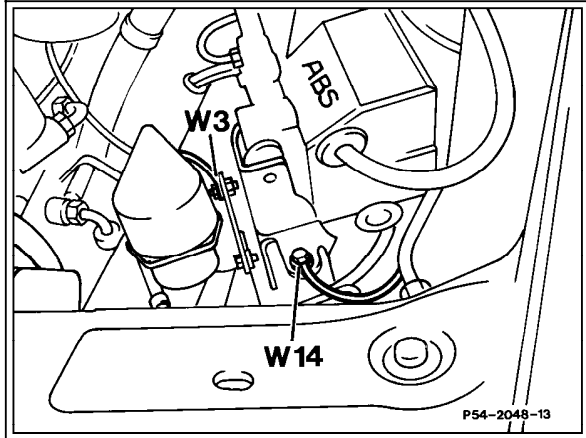

P54-2048-13

Figure 10

- W3 Ground, left front wheelhousing (at ignition coil)
- W14 Ground, ABS hydraulic unit bracket

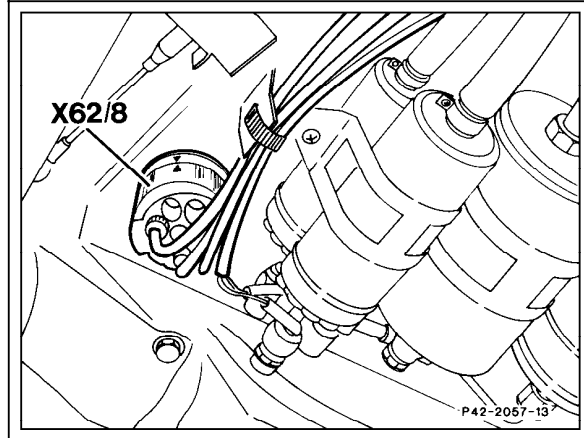

P42-2057-13

Figure 11

- X62/8 Rear axle multiple circuit junction connector

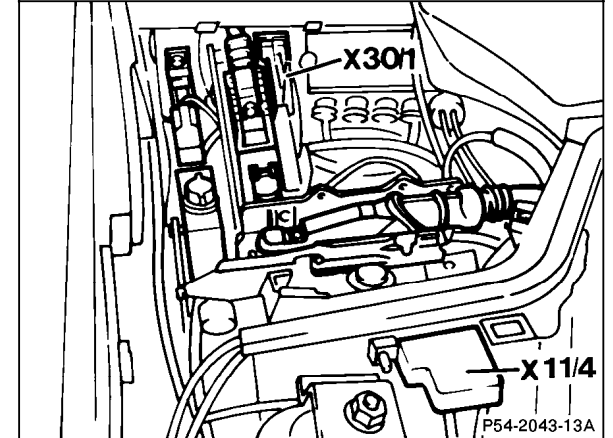

P54-2043-13A

Figure 12

- X11/4 Diagnostic connector (diagnostic trouble code, 16-pole)
- X30/1 Multi-function block connector

Electrical Test Program - Test

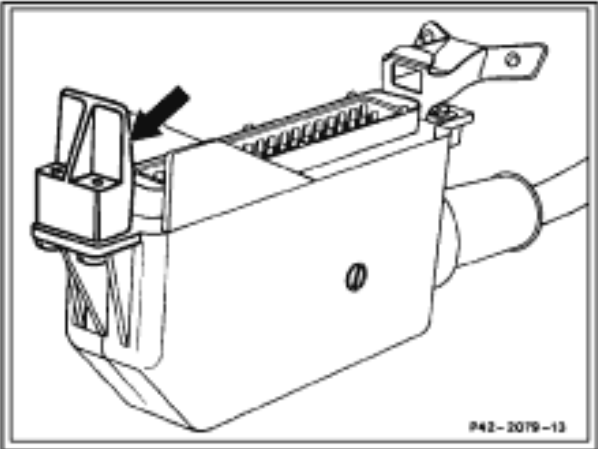

P42-2079-13

Figure 13

ABS Adapter plug