

Diagnosis - Diagnostic Trouble Code (DTC) Memory

Preliminary work: Engine Test, Adjustment, Engines (SMS, Job No. 07-1100)

⚠ WARNING!

Risk of severe injury when touching ignition parts which produce high voltages. Do not touch ignition components.

Persons with heart pacemakers are not to perform repairs on this type of ignition system..

Electronic ignition systems produce dangerous high voltages on both the primary circuit and the secondary (ignition) circuits. Due to the high voltages produced, contact with any of the voltage carrying components can be dangerous to your health (burns, heart palpitations, cardiac arrest etc).

- Ignition must be turned OFF prior to performing any repair work on the ignition system.
- Do not come in contact or remove with any of the ignition components while the engine is cranking or idling.
- Wear rubber soled shoes.
- Disconnect connectors for CKP sensor at sensor or control module.
- If repairs require that the ignition be turned on, then dangerous voltages will be present through out the entire ignition system.
- No exposed metal connectors or sending units may be installed in the ignition wires.

⚠ WARNING!

Risk of fatal injury from being pulled into rotating vehicle parts.

Do not reach into rotating parts.

Wear closed and tight-fitting work clothes.

Protect vicinity of rotating vehicle components from unauthorized access.

⚠ WARNING!

Risk of explosion from fuel igniting, risk of poisoning from inhaling and swallowing fuel as well as risk of injury to eyes and skin from contact with fuel.

No fire, sparks, exposed flames or smoking.

Pour fuels only into suitable and appropriately marked containers.

Wear protective clothing when handling fuel.

Possible hazards

Risk of explosion, poisoning and injury

Fuels are highly inflammable and toxic if inhaled. Fuel may cause skin damage. Contact with gasoline fuel, for example, removes the natural oils on the skin. Fuel vapors are explosive, invisible and spread out at floor level. They are toxic if inhaled and have a narcotic effect in high concentrations.

Protective measures/guidelines

- Pay attention to national safety regulations and provisions.
- No fire, sparks, exposed flames or smoking.
- Ensure that the place of work is adequately ventilated.
- Never drain or pour in fuels over assembly pits.
- Store drained fuel in suitable and sealed containers.
- Immediately eliminate any fuel spills which have been spilled out of the container.

Continued on next page:

Diagnosis - Diagnostic Trouble Code (DTC) Memory

Note regarding diagnostic trouble code (DTC) readout:

The engine control module (N3/10) for the ME-SFI system is equipped with diagnostic trouble code (DTC) memory. Malfunctions are recognized and stored as DTC's and are distinguished as follows:

- Malfunctions which are constantly present,
- Intermittent contact malfunctions which have occurred during a trip and have been stored.

The DTC memory is erased when the vehicle's battery is disconnected.

Malfunctions which are no longer present, are automatically erased as follows:

- After three trips the "CHECK ENGINE" MIL goes out.
- After an additional 40 warm-up periods the DTC is automatically erased.
- "CHECK ENGINE" MIL is illuminated if the fault was stored on the previous driving-cycle.

A warm-up period or trip is defined as follows:

Warm-up period

- Engine coolant temperature at start < 35° C,
- Engine coolant temperature increases to > 70° C.

Trip

- Engine running for > 20 minutes,
- Engine oil temperature > - 7° C,
- Engine speed > 500 rpm,
- All emission related logic chain functions already there were checked during previous trips.

Driving-cycle (for a test) consists of:

- Engine start
- Completion of test,
- Shutting engine: OFF

The stored DTC's can be read at the data link connector (X11/4) **using the HHT only**, with the ignition switched "ON" or with the "engine running". Readout via an on-off ratio readout or impulse counter scan tool has been eliminated.

AS required by law, the DTC's can be read out using the Generic Scan Tool, by connecting scan tool to the diagnostic connector (X11/4), based on the SAE, ISO 9141-2 standards .

Diagnosis - Diagnostic Trouble Code (DTC) Memory

Conducting work on a vehicle with exposed flame

(e.g. welding etc.)

- Prior to commencing such work, remove appropriate parts of the fuel system and seal open fuel lines with plugs.

First-aid measures

- Clean contaminated/exposed skin with water and soap.
- Change contaminated clothing as quickly as possible.
- If fuel gets into the eyes, rinse out eyes immediately with water, and contact a doctor, if necessary.

To Avoid Damage to the Ignition System

- To avoid damage to the engine control module, connect/disconnect the control module connectors only with the ignition: **OFF**.
- Circuit 1 of the ignition coil may not be shorted to ground, e.g. theft deterrence.
- Only original equipment should be installed in the ignition system.
- Do not operate the ignition system at cranking speed unless the entire ignition harness is connected.
- Do not perform any tests (grounding of ignition cable 4 disconnecting a spark plug connector or pulling cable 4 out of the ignition coil) at cranking or idle speed.

- The high output side of the ignition system must carry at least 2 kΩ of load (spark plug connector).
- If assisting a disabled vehicle and it becomes necessary to perform an ignition spark test, perform this test only on one ignition/spark plug. Ensure a good ground connection to the spark plug.
- ME - SFI: the ignition system is to be turned OFF, when cranking engine to perform compression tests, additionally, it is necessary to disconnect connector 2 from the control module.

 Engine 120 has separate ignition and fuel injection system.



Readout via the impulse counter scan tool is not possible.

Note:

Symbol for emission related malfunctions which lead to the activation of the CHECK ENGINE MIL when a certain test cycle was performed and a fault was recognized.

Diagnosis - Diagnostic Trouble Code (DTC) Memory

Note regarding mixture preparation self-adaptation:

The Lambda control system determines the fuel injection duration so precisely that the fuel/air ratio is kept constant at Lambda level 1 (equals 14.7 kg air to 1 kg fuel) under all operating conditions.

Should malfunctions occur in the form of:

- Intake air leaks,
- Injector wear or carbon build-up,
- Engine wear,
- Transition resistance in MAF sensor,
- Defective diaphragm pressure regulator,
- Defective purge control valve,

the engine control module (ME-SFI, 2.0) automatically performs a mixture adjustment.

The degree of correction is constantly calculated and permanently stored.

The self-adaptation is performed additive at idle and multiplicative under partial load. The correction towards rich or lean is ± 1.0 milliseconds (injection duration) at idle and the factor 0.68 – 1.32 at partial load. After repair work is performed, the engine control module will automatically adapt itself again.

Note regarding drive authorization system (DAS 3):**Model Year 1998, models 202, 208 and 210**

Vehicles with ME-SFI (ME 2.0) are equipped with DAS 3. DAS is activated from the DAS control module (N54/1) via the CAN data bus to the engine control module.

Upon activation of the DAS, the engine control module renders the fuel injection system inoperative. The activation or deactivation is accomplished only with the electronic ignition key. As soon as the electronic ignition key is inserted in the steering lock, the DAS control module receives a signal and activates the engine control via the CAN data bus.

The locking and unlocking of the vehicle, using the mechanical key has no effect on the DAS system.

The engine control module and the DAS control module are “married” to one another through identification codes. The identification codes can not be erased (see HHT nominal values “DAS”, menu selection 3/7).

Therefore, swapping the engine or RCL control module from one vehicle to another is not possible!

Diagnosis - Diagnostic Trouble Code (DTC) Memory



If an exchange engine control module is installed for test purposes, up to 40 start attempts can be performed before the engine and DAS control modules “marry” to one another. Prior to performing the first start, the engine control module must be version coded using the HHT. Additionally, the code number and VIN must be entered (see HHT nominal values “DAS”, menu selection 3/7).

Note regarding version coding:

The engine control module is equipped with a version coding feature. The coding must be performed with the Hand-Held Tester (automatically or manually, see Notes for HHT “Version coding” 11/5) upon installation of a new control module.

The following vehicle version data must be determined for coding:

- Vehicle model,
- Engine,
- Manual/automatic transmission
- Non-catalytic converter (non-TWC),
- Country version,
- 30 km/h limitation

Diagnosis - Diagnostic Trouble Code (DTC) Memory

Notes regarding automatic recognition of the mechanical end stop and wide open position of the throttle valve from the actuator:

The end stops of the throttle valve is determined by the actuator and stored in the engine control module.

After replacing the control module or actuator, the mechanical end stop and wide open position must again be determined and recorded.

Thereby allowing learned data to be erased with the HHT and new data to be learned. When the new engine control module is connected for the first time to circuit 30 (B+), the engine control module performs a self-adaptation of the actuator with the ignition "ON" (lower mechanical end stop and wide open position of the throttle valve).

Requirements for learning process:

- Selector lever in position P/N,
- Vehicle standing still,
- Engine off,
- Engine coolant temperature between 5° C and 100° C,
- Accelerator pedal not applied.

When all requirements are met, turn **ignition ON for at least 60 seconds**, then turn **ignition OFF for at least 10 seconds**.

The learned value is stored in memory, only after the first 10 start cycles, provided the voltage supply has not been interrupted. Should the battery be disconnected after the 9th start cycle, the re-learning process must be performed again.

Notes regarding VSS sensor adaption for rough running engine test:

After the replacement of the ME-SFI control module, CKP sensor (L5), starter ring gear or motor mount, a sensor adaption must be performed:

- Engine coolant temperature approx. > 70 °C,
- Drive vehicle on road.

Vehicles up to 01/98:

- With selector lever in position 4: Increase engine rpm to approx. 2,500 rpm and then coast until engine rpm is approx. < 1,500 rpm.
- With selector lever in position 2: Increase engine rpm to approx. 6,100 rpm and then coast until engine rpm is approx. < 4,100 rpm. Again increase engine rpm to approx. 6,100 rpm and then coast until engine rpm is approx. < 3,000 rpm.
- Using the HHT, determine if VSS sensor adaption has taken place.

Vehicles as of 02/98:

- With selector lever in position 3: Increase engine rpm to approx. 2,100 rpm and then hold a 50% engine load for approx. 30 seconds.
- Using the HHT, determine if VSS sensor adaption has taken place.

Notes regarding performance/speedometer test:

Disconnecting the ESP/ASR/ETS/ABS control modules is not allowed. The engine control module and transmission control module rely on these modules to supply the VSS data via the CAN bus.

To disable the brake and engine regulation function of the ESP/ASR/ETS/ABS control modules:

(continued on 11/7)

Diagnosis - Diagnostic Trouble Code (DTC) Memory

Notes for HHT

A. Working without HHT

- Ignition: **OFF**.
- Connect HHT adapter to data link connector (X11/4).
- Bridge sockets 1 and 6.
- Engine: **Start** (BAS/ESP or BAS/ASR MIL must illuminate!).

B. Working with HHT

- Ignition: **OFF**.
- Disconnect front axle VSS sensor connector (BAS/ESP or BAS/ASR MIL must illuminate!).

When work is completed, reconnect VSS sensor connector and erase DTC's with HHT!

• Fault search with HHT

Diagnostic trouble code (DTC) memory: Select "Current DTC's".
If the actual condition changes, e.g. when wiggling a connector, the change is reported optically and acoustically so that troubleshooting can be performed directly with the HHT.

• Version coding with HHT

- Before replacement of the engine control module, the existing code number must be read and stored with the HHT (menu selection 5 "Version coding"). After installation of the new control module, the previously read code number must be entered.



If returning a new control module to a PDC, the code number must be erased.

- If the code number can **not** be read, the vehicle equipment/version must be determined, the corresponding code number obtained from the Spare Parts Microfiche (group 54) and manually entered with the HHT.

• Loose connections

Loose connections are stored if they occur several times in a certain time period. Therefore, they can appear only as "Stored DTC's" and never as "Current DTC's".

• Nominal values

All nominal values relative to the actual values shown on the HHT are listed in the Diagnostic Manual, Engines, Volume 1, section A.

• Actual value for engine speed

For engine speed, the HHT display indicates the closed throttle speed (CTP) nominal value calculated by the control module on the left, and the rpm actual value on the right. Both values should differ from each other only slightly. Permissible tolerances are not yet determined.

• Drive authorization system (DAS) X

Upon replacement the engine control module must be version coded using the HHT. Additionally, the code number and VIN must be entered (see HHT nominal values "DAS", menu selection 3/7).

Diagnosis - Diagnostic Trouble Code (DTC) Memory

Special Tools



965 589 00 01 00

Hand-Held-Tester

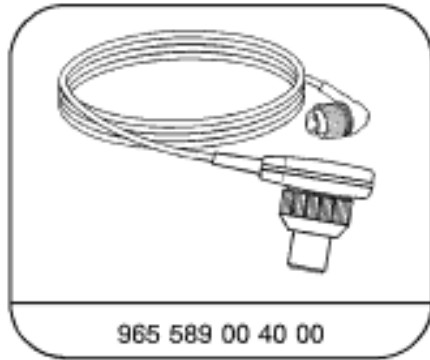

965 589 00 40 00

Test cable

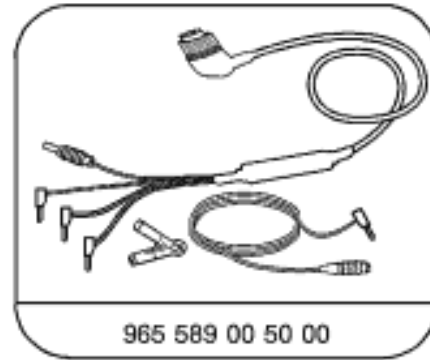

965 589 00 50 00

Adapter cable

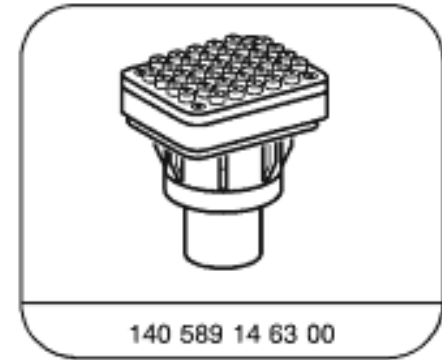

140 589 14 63 00

Adapter

Diagnosis - Diagnostic Trouble Code (DTC) Memory

Connection Diagram - Hand-Held Tester (HHT)

1. Connect HHT (087) with test cable (097) to data link connector (X11/4)
2. Ignition: **ON**
3. As per display in HHT:
 - a) read out/erase DTC memory
 - b) read out actual values
 - c) perform activations
 - d) program control modules
4. Disconnect HHT



Observe system specific notes, which are described in the beginning of each chapter. Erase all stored faults which come about when tests or simulations are performed, upon completion of the repairs.

Figure 1

087	Hand-Held Tester
094	Multiplexer cable
X11/4	Data link connector (DTC readout) (38-pole)

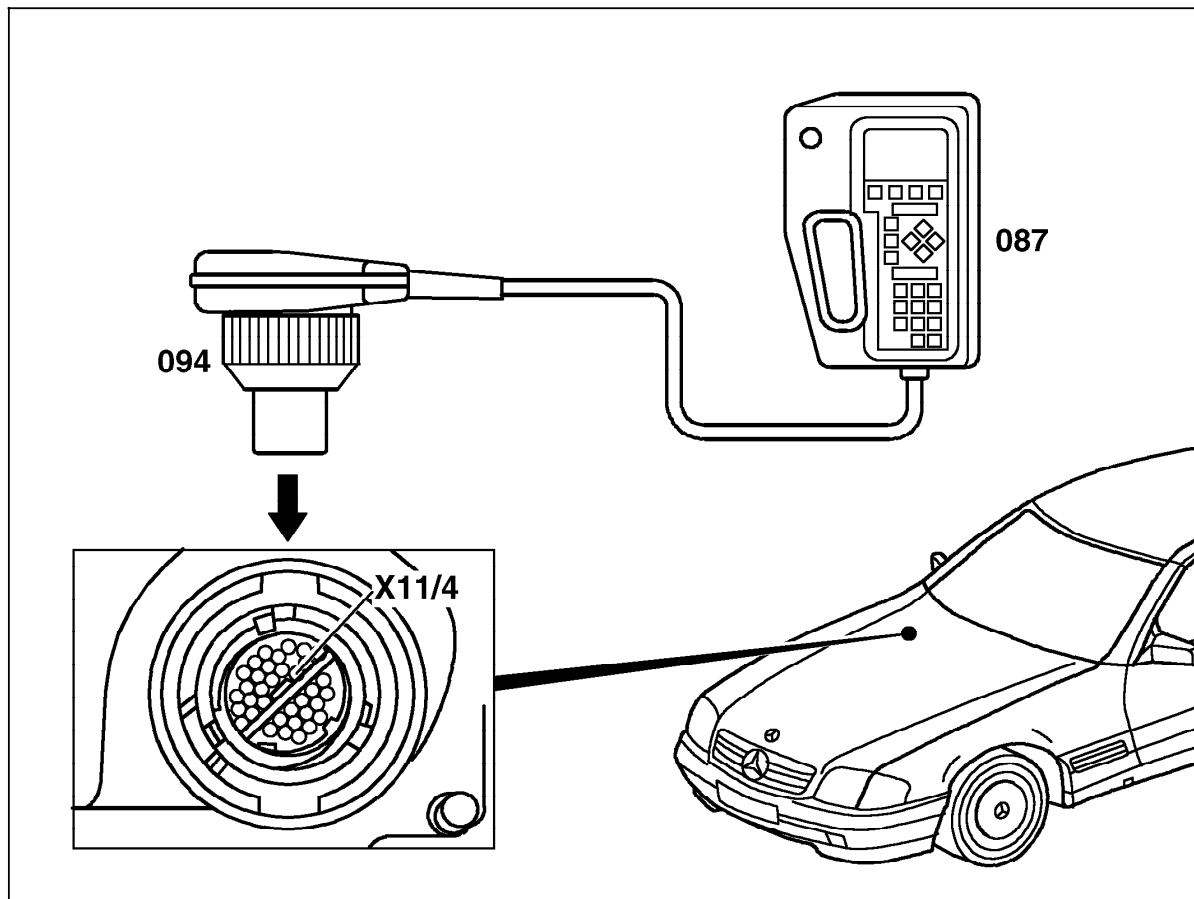

P00.19-0411-06

Diagnosis – Diagnostic Trouble Code (DTC) Memory

Prerequisites for readout of DTC memory



WARNING!

Risk of severe injury when touching ignition parts which produce high voltages. Do not touch ignition components.

Persons with heart pacemakers are not to perform repairs on this type of ignition system.



Readout via the impulse counter scan tool is not possible.

Note:

Symbol for emission related malfunctions which lead to the activation of the CHECK ENGINE MIL when a certain test cycle was performed and a fault was recognized in the prior trip cycle. The CHECK ENGINE MIL will illuminate immediately if a "TWC damaging" missfire is found.

Preparation for Test:



1. Connect HHT with test cable to data link connector (X11/4), readout DTC fault codes.
2. Review 22,
3. Review 11, 21, 23, 24, 31, 33,
4. Perform Test and adjustment of engine, see DM, Engines, Vol. 1, section B, if necessary.
5. Ignition: **ON**

Diagnosis – Diagnostic Trouble Code (DTC) Memory

DTC 	Possible cause		Test step/Remedy ¹⁾
	SAE nomenclature	Explanation	
–	No malfunction in system		In case of complaint, perform 23, 24, 25 or 26 in its entirety.
P0100	MAF circuit malfunction	Hot film MAF sensor (B2/5) DTC description	23⇒ 4.0 11/26
P0105 Only (USA)	MAP circuit malfunction	Pressure sensor (B28) DTC description	23⇒ 6.0 11/27
P0110	IAT circuit malfunction	IAT sensor (in Hot film MAF sensor B2/5) DTC description	23⇒ 5.0 11/28
P0115	ECT circuit malfunction	ECT sensor (B11/4) DTC description	23⇒ 8.0 11/29
P0120	Throttle position circuit malfunction	Actual value potentiometer in EA/CC/ISC actuator (M16/6) DTC description	25⇒ 3.0 11/30



1) Observe Preparation for Test, see 22.

Diagnosis – Diagnostic Trouble Code (DTC) Memory

DTC 	Possible cause		Test step/Remedy ¹⁾
	SAE nomenclature	Explanation	
P0130	O2S 1 circuit malfunction	A. O2S 1 (before TWC) (G3/4) B. O2S 1 (before TWC) (G3/4), voltage increase insufficient DTC description	23⇒ 11.0 11/31
P0133	O2S 1 circuit slow response	A O2S 1 (before TWC) (G3/4), ageing correction value exceeded B O2S 1 (before TWC) (G3/4), ageing time period too long C O2S 1 (before TWC) (G3/4), ageing O2S 1 sensor response too slow DTC description	23⇒ 11.0 11/32
P0135	O2S 1 heater circuit malfunction	O2S 1 heater (before TWC) (G3/4) DTC description	23 ⇒ 13.0 11/34
P0136 Only 	O2S 2 circuit malfunction	O2S 2 (after TWC) (G3/6) DTC description	23 ⇒ 15.0 11/31
P0140	O2S 1 circuit malfunction	O2S 1 (before TWC) (G3/4) DTC description	23⇒ 11.0 11/31
P0141 Only 	O2S 1 heater circuit malfunction	O2S 1 (after TWC) (G3/6) DTC description	23⇒ 17.0 11/34
P0150	O2S 1 circuit malfunction	A O2S 1 heater (before TWC) (G3/3) B O2S 1 heater (before TWC) (G3/3), voltage increase too slow DTC description	23⇒ 10.0 11/31

1) Observe Preparation for Test, see 22.

Diagnosis – Diagnostic Trouble Code (DTC) Memory

DTC 	Possible cause		Test step/Remedy ¹⁾
	SAE nomenclature	Explanation	
P0153	O2S 1 circuit slow response	A O2S 1 heater (before TWC) (G3/3), ageing correction value exceeded B O2S 1 heater (before TWC) (G3/3), ageing time period too long C O2S 1 heater (before TWC) (G3/3), ageing O2S 1 sensor response too slow DTC description	23⇒ 10.0 11/32
P0155	O2S 2 heater circuit malfunction	Left O2S 1 heater (before TWC) (G3/3) DTC description	23⇒ 12.0 11/34
P0156 Only 	O2S 2 circuit malfunction	Left O2S 2 (after TWC) (G3/5) DTC description	23⇒ 14.0 11/31
P0160	O2S 2 heater circuit malfunction	Left O2S 1 heater (before TWC) (G3/3) DTC description	23⇒ 14.0 11/31
P0161 Only 	O2S 2 heater circuit malfunction	Right O2S 2 heater (after TWC) (G3/5) DTC description	23⇒ 16.0 11/34
P0170	Fuel trim malfunction	A Self adaptation of fuel mixture “partial load“, right cylinder bank, at limit from engine control module (N3/10). B Self adaptation of fuel mixture “CTP“, right cylinder bank, at limit from engine control module (N3/10). DTC description	Intake air leak, injectors, diaphragm pressure regulator, engine wear. 11/35

¹⁾ Observe Preparation for Test, see 22.

Diagnosis – Diagnostic Trouble Code (DTC) Memory

DTC 	Possible cause		Test step/Remedy ¹⁾
	SAE nomenclature	Explanation	
P0173	Fuel trim malfunction	A Self adaptation of fuel mixture “partial load“, left cylinder bank, at limit from engine control module (N3/10). B Self adaptation of fuel mixture “CTP“, left cylinder bank, at limit from engine control module (N3/10). DTC description	Intake air leak, injectors, diaphragm pressure regulator, engine wear. 11/35
P0201	Injector circuit malfunction - cyl. 1	Injector (Y62y1) – cylinder 1 DTC description	23 ⇒ 18.0 11/36
P0202	Injector circuit malfunction - cyl. 2	Injector (Y62y2) – cylinder 2 DTC description	23 ⇒ 19.0 11/36
P0203	Injector circuit malfunction - cyl. 3	Injector (Y62y3) – cylinder 3 DTC description	23 ⇒ 20.0 11/36
P0204	Injector circuit malfunction - cyl. 4	Injector (Y62y4) – cylinder 4 DTC description	23 ⇒ 21.0 11/36
P0205	Injector circuit malfunction - cyl. 5	Injector (Y62y5) – cylinder 5 DTC description	23 ⇒ 22.0 11/36
P0206	Injector circuit malfunction - cyl. 6	Injector (Y62y6) – cylinder 6 DTC description	23 ⇒ 23.0 11/36

1) Observe Preparation for Test, see 22.

Diagnosis – Diagnostic Trouble Code (DTC) Memory

DTC 	Possible cause		Test step/Remedy ¹⁾
	SAE nomenclature	Explanation	
P0 300	Random misfire detected	A Random misfire B Random misfire, TWC damaging DTC description	24 ⇒ 11.0 – 17.0 36 ⇒ 1.0 – 2.0 Compression pressure 11/37
P0 301	Cylinder 1 misfire detected	A Cylinder 1 misfire B Cylinder 1 misfire, TWC damaging DTC description	24 ⇒ 11.0 24 ⇒ 17.0 36 ⇒ 1.0 – 2.0 Compression pressure 11/37
P0 302	Cylinder 2 misfire detected	A Cylinder 2 misfire B Cylinder 2 misfire, TWC damaging DTC description	24 ⇒ 12.0 24 ⇒ 17.0 36 ⇒ 1.0 – 2.0 Compression pressure 11/37
P0 303	Cylinder 3 misfire detected	A Cylinder 3 misfire B Cylinder 3 misfire, TWC damaging DTC description	24 ⇒ 13.0 24 ⇒ 17.0 36 ⇒ 1.0 – 2.0 Compression pressure 11/37





¹⁾ Observe Preparation for Test, see 22.

Diagnosis – Diagnostic Trouble Code (DTC) Memory

DTC 	Possible cause		Test step/Remedy ¹⁾
	SAE nomenclature	Explanation	
P0 304	Cylinder 4 misfire detected	A Cylinder 4 misfire B Cylinder 4 misfire, TWC damaging DTC description	24 ⇒ 14.0 24 ⇒ 17.0 36 ⇒ 1.0 – 2.0 Compression pressure 11/37
P0 305	Cylinder 5 misfire detected	A Cylinder 5 misfire B Cylinder 5 misfire, TWC damaging DTC description	24 ⇒ 15.0 24 ⇒ 17.0 36 ⇒ 1.0 – 2.0 Compression pressure 11/37
P0 306	Cylinder 6 misfire detected	A Cylinder 6 misfire B Cylinder 6 misfire, TWC damaging DTC description	24 ⇒ 16.0 24 ⇒ 17.0 36 ⇒ 1.0 – 2.0 Compression pressure 11/37
P0 325	KS 1 circuit malfunction	Right KS 1 (A16g1) DTC description	Wiring, connector, A16g1 11/40
P0 330	KS 2 circuit malfunction	Left KS 2 (A16g2) DTC description	Wiring, connector, A16g2 11/40

1) Observe Preparation for Test, see 22.

Diagnosis – Diagnostic Trouble Code (DTC) Memory

DTC 	Possible cause		Test step/Remedy ¹⁾
	SAE nomenclature	Explanation	
P0335	CKP sensor circuit malfunction	CKP sensor (L5) DTC description	24 ⇒ 9.0 11/41
P0341	CMP sensor circuit range/performance	Camshaft Hall-effect sensor (B6/1) DTC description	24 ⇒ 10.0 11/41
P0370	Angle deviation between camshaft and crankshaft	Angle deviation between camshaft and crankshaft	Check basic adjustment of camshaft
P0400	Exhaust gas recirculation flow malfunction	Exhaust gas recirculation malfunction (logic chain) DTC description	23 ⇒ 27.0 11/42
P0410 Only 	Air injection system malfunction	AIR system malfunction (logic chain) DTC description	23 ⇒ 24.0– 26.0 11/43
P0422	TWC (right) efficiency below threshold	TWC efficiency below threshold DTC description	Replace right TWC 11/45
P0432	TWC (left) efficiency below threshold	TWC efficiency below threshold DTC description	Replace left TWC 11/45
P0440 Only 	EVAP system malfunction	EVAP malfunction (logic chain) DTC description	23 ⇒ 30.0 – 31.0 11/47
P0441 Only 	EVAP system malfunction (function)	Purge control valve (Y58/1) function DTC description	23 ⇒ 29.0 – 30.0 11/47
P0442 Only 	EVAP system leak detected (small leak)	EVAP system, small leak DTC description	23 ⇒ 31.0 11/47



1) Observe Preparation for Test, see 22.

Diagnosis – Diagnostic Trouble Code (DTC) Memory

DTC 	Possible cause		Test step/Remedy ¹⁾
	SAE nomenclature	Explanation	
P0443	EVAP system purge control valve circuit malfunction	Purge control valve (Y58/1) DTC description	23 ⇒ 29.0 11/51
P0446 Only (USA)	EVAP system vent control malfunction	A. Activated charcoal canister shut-off valve (Y58/4) (logic chain) B. End stage activated charcoal canister shut-off valve (Y58/4) DTC description	23 ⇒ 32.0, 23 ⇒ 33.0, N3/10 11/52
P0450 Only (USA)	EVAP system pressure sensor malfunction	A. Fuel tank pressure sensor (B4/3) electrical fault B. Fuel tank pressure sensor (B4/3) electrical fluctuations DTC description	23 ⇒ 33.0 Charcoal canister plugged. 11/53
P0455 Only (USA)	EVAP system leak detected (large leak)	EVAP system, large leak Fuel tank pressure sensor (B4/3) (voltage supply) DTC description	23 ⇒ 31.0 23 ⇒ 33.0 11/48
P0460	Fuel level sensor circuit low input	Fuel tank level too low DTC description (missfire)	Readout instrument cluster memory 11/46

1) Observe Preparation for Test, see 22.

Diagnosis – Diagnostic Trouble Code (DTC) Memory

DTC 	Possible cause		Test step/Remedy ¹⁾
	SAE nomenclature	Explanation	
P0 500	VSS sensor malfunction	A VSS left front B VSS left rear DTC description (speed signal)	Test ASR, ESP see DM, Chassis and Drivetrain, Vol. 3, section 9.0 and 10.2 11/54
P0 507	ISC rpm higher than expected	Idle control system, unplausible DTC description	25 ⇒ 1.0 – 3.0 11/55
P0 560	System voltage malfunction	Voltage supply to engine control module (N3/10) DTC description (voltage supply at engine control module)	23 ⇒ 1.0 – 2.0 11/56
P0 565	Cruise control switch	CC switch with variable speed (S40/4)	Not 
P0 600	Serial communication link malfunction	CAN bus from ESP/SPS control module (N47-5) DTC description (CAN distorted)	23 ⇒ 34.0 11/57
P0 604	Internal control module random Access memory (RAM) error	A Engine control module (N3/10) B Engine control module (N3/10)	(N3/10)
P0 605	Internal control module read only memory (ROM) error	Engine control module (N3/10)	(N3/10)
P0 700	Transmission control system malfunction Gear unplausi. or transmission leak, Command valve sticks in pressure position	Read DTC memory of transmission control module. DTC description DTC description	Test ETC, see DM, Chassis & Drivetrain, Vol. 1, section 2.3, 23 11/58 11/59

1) Observe Preparation for Test, see 22.

Diagnosis – Diagnostic Trouble Code (DTC) Memory

DTC 	Possible cause		Test step/Remedy ¹⁾
	SAE nomenclature	Explanation	
P0702	Transmission control system electrical Transmission control module Solenoid valves, voltage supply	Read DTC memory of transmission control module. DTC description DTC description	Test ETC, see DM, Chassis & Drivetrain, Vol. 1, section 2.3, 23 11/60 11/61
P0715	Input/turbine speed sensor circuit malfunction, RPM sensor function	Read DTC memory of transmission control module. DTC description	Test ETC, see DM, Chassis & Drivetrain, Vol. 1, section 2.3, 23 11/62
P0720	Output speed sensor circuit malfunction, (CAN fault)	Read DTC memory of transmission control module. DTC description	Test ETC, see DM, Chassis & Drivetrain, Vol. 1, section 2.3, 23 11/64
P0730	Incorrect gear ratio	Read DTC memory of transmission control module. DTC description	Test ETC, see DM, Chassis & Drivetrain, Vol. 1, section 2.3, 23 11/65
P0740	Torque converter lock-up clutch circuit malfunction	Read DTC memory of transmission control module. DTC description	Test ETC, see DM, Chassis & Drivetrain, Vol. 1, section 2.3, 23 11/66
P0743	Torque converter clutch circuit electrical	Read DTC memory of transmission control module. DTC description	Test ETC, see DM, Chassis & Drivetrain, Vol. 1, section 2.3, 23 11/67

1) Observe Preparation for Test, see 22.

Diagnosis – Diagnostic Trouble Code (DTC) Memory

DTC 	Possible cause		Test step/Remedy ¹⁾
	SAE nomenclature	Explanation	
P0 748	Pressure control solenoid electrical, Modulating press. reg. solenoid valv., Shift pressure reg. solenoid valve	Read DTC memory of transmission control module. DTC description	Test ETC, see DM, Chassis & Drivetrain, Vol. 1, section 2.3, 23 11/68 11/69
P0 753	Shift solenoid A electrical 1-2/4-5 solenoid valve	Read DTC memory of transmission control module. DTC description	Test ETC, see DM, Chassis & Drivetrain, Vol. 1, section 2.3, 23 11/70
P0 758	Shift solenoid B electrical 2-3 shift solenoid valve	Read DTC memory of transmission control module. DTC description	Test ETC, see DM, Chassis & Drivetrain, Vol. 1, section 2.3, 23 11/71
P0 763	Shift solenoid C electrical 3-4 shift solenoid valve	Read DTC memory of transmission control module. DTC description	Test ETC, see DM, Chassis & Drivetrain, Vol. 1, section 2.3, 23 11/72
P0 801	Engine/climate control electric cooling fan malfunction	Engine/climate control electric cooling fan (M4/3)	23 ⇒ 36.0
P0 802	Resonance intake manifold switchover valve malfunction	Resonance intake manifold switchover valve (Y22/6)	23 ⇒ 28.0
P0 809	Angle deviation between camshaft and crankshaft	Angle deviation between camshaft and crankshaft	Check basic adjustment of camshaft.



1) Observe Preparation for Test, see 22.

Diagnosis – Diagnostic Trouble Code (DTC) Memory

DTC 	Possible cause		Test step/Remedy ¹⁾
	SAE nomenclature	Explanation	
P0 811	CAN from electronic ignition lock	CAN from electronic ignition lock.	23 ⇒ 34.0
P1 031	O2 sensors (G3/3, G3/4) reversed	O2 sensors (G3/3, G3/4) reversed.	Check proper connection of O2 sensors in ETM.
P1 177	Oil sensor	Oil sensor (level, temperature, quality)(B40), Oil temperature implausible.	23 ⇒ 35.0
P1 178	Oil sensor	Oil sensor (level, temperature, quality)(B40), Oil level implausible.	23 ⇒ 35.0
P1 179	Oil sensor	Oil sensor (level, temperature, quality)(B40), Oil quality implausible.	23 ⇒ 35.0
P1 180	Oil sensor	Oil sensor (level, temperature, quality)(B40), Oil temperature too high.	23 ⇒ 35.0
P1 181	Engine/climate control electric cooling fan	Faulty	23 ⇒ 36.0
P1 185	Oil sensor	Oil sensor (level, temperature, quality)(B40), water in oil.	23 ⇒ 35.0
P1 186	Fuel safety shut-off recognized	EA/CC/ISC actuator (M16/6)	25 ⇒ 3.0 – 4.0, EA/CC/ISC actuator (M16/6) sticks or jammed, Check intake system for residue.
P1 225	Resonance intake manifold switchover valve	Resonance intake manifold switchover valve (Y22/6)	23 ⇒ 28.0

1) Observe Preparation for Test, see 22.

Diagnosis – Diagnostic Trouble Code (DTC) Memory

DTC 	Possible cause		Test step/Remedy ¹⁾
	SAE nomenclature	Explanation	
P1 233	Throttle valve setting element	Throttle valve setting element (M16/6) sticks due to icing	Replace element.
P1 386	Knock sensor control from ECM (N3/10) at end stop	Knock sensor regulation from engine control module (N3/10) at end stop DTC description	1. Increased knock tendency due to bad fuel, carbon in combustion chamber or mechanical damage. 11/73
P1 400	EGR valve vacuum transducer	EGR valve vacuum transducer (Y31/1) faulty DTC description	23 ⇒ 27.0 11/74
P1 420 Only 	AIR pump switchover valve	AIR pump switchover valve (Y32) DTC description	23 ⇒ 25.0 11/75
P1 453 Only 	AIR relay module, AIR pump	Relay module, AIR pump (K40/4k3) in relay module (K40) DTC description	23 ⇒ 24.0 11/75
P1 491		Refrigerant pressure in A/C system too high	Check automatic A/C system.
P1 542	Pedal value sensor	Pedal value sensor (B37) DTC description	25 ⇒ 1.0 – 2.0 11/76

¹⁾ Observe Preparation for Test, see 22.

Diagnosis – Diagnostic Trouble Code (DTC) Memory

DTC 	Possible cause		Test step/Remedy ¹⁾
	SAE nomenclature	Explanation	
P1 570	CAN signal from DAS control module to engine control module	A. Start attempted with "locked" DAS B. CAN signal from DAS control module (N54/1) to engine control module (N3/10) interrupted. C. Engine control module (ME-SFI) and DAS control module are not compatible.	User error, Check correct operation of DAS, see DM, Body and Accessories, Vol. 1, 4.9, 4.10 23 ⇒ 34.0 Check control modules and part no.
P1 580	EA/CC/ISC actuator	Throttle valve setting element (M16/6) DTC description	25 ⇒ 3.0 – 4.0 11/77
P1 584	Stop lamp switch	Stop lamp switch (S9/1)	Test ETS, ASR see DM, Chassis & Drivetrain, Vol. 3, 10.2
P1 603	CAN from EIS		25 ⇒ 34.0
P1 605		Poor road/traction condition recognition signal (via comparison of VSS rpm signals)	Test ASR/ESP see DM, Chassis and Drivetrain, Vol. 3, Section 9, 10.2
P1 642		Engine control module incorrectly coded (coded for MT, vehicle has AT)	Check version coding and correct, see 11
P1 643		Engine control module incorrectly coded (coded for MT, vehicle has AT) or No CAN transmission from transmission control module (N15/3)	Check version coding and correct, see 11, Test ETC, see DM, Chassis & Drivetrain, Vol. 1, section 2, 23

1) Observe Preparation for Test, see 22.

Diagnosis – Diagnostic Trouble Code (DTC) Memory

DTC 	Possible cause		Test step/Remedy ¹⁾
	SAE nomenclature	Explanation	
P1 644		Transmission version can not be checked due to low voltage at transmission control module (N15/3)	Test ETC, see DM, Chassis & Drivetrain, Vol. 1, section 2.3, 23
P1 747	CAN signal from ETC	A. CAN failure: Transmission protection malfunction from transmission control module (N15/3) B. CAN failure: Instrument cluster DTC description	Test ETC, see DM, Chassis & Drivetrain, Vol. 1, section 2.3, 23 Test instrument cluster (A1), see DM, Body & Accessories, Vol. 1 11/57

¹⁾ Observe Preparation for Test, see 22.

Diagnosis – Diagnostic Trouble Code (DTC) Memory

DTC P0100	Hot film MAF sensor (B2/5)
Fault memory and activation of Check Engine (MIL)	At end of test duration and fault, two in sequence driving-cycles with faults
Test frequency	Continuously
Tested signal or condition	Limit signals, MAF (B2/5)
Magnitude: lower limit Lower threshold limit Upper threshold limit Test duration	At idle approx. 4-35 kg/h (1.3-1.7 v) min. 16kg/h, if throttle plate angle is greater than 14° approx. 50-900 kg/h, ECM map based on engine rpm and throttle plate angle. approx. 5 sec. per limit.
Tested pre-requisites	No fault in throttle plate adjustment

Diagnosis – Diagnostic Trouble Code (DTC) Memory

DTC P0105	Pressure sensor (B28)
Fault memory and activation of Check Engine (MIL)	At end of test duration and fault, two in sequence driving-cycles with faults
Test frequency	Continuously
Tested signal or condition	Limit values, Pressure sensor (B28)
Magnitude: lower limit Lower threshold limit Upper threshold limit Test duration	min -60 mbar, with engine rpm over 1300 rpm approx. 0 mbar, if throttle plate angle is greater than 80° approx. 500-1200 mbar, ECM map dependent on engine rpm and throttle plate angle. approx. 5 sec. per limit.
Test pre-requisites	Lock time period of 30 seconds after start exceeded and no fault in the throttle plate angle.

Diagnosis – Diagnostic Trouble Code (DTC) Memory

DTC P0110	IAT sensor (in Hot film MAF sensor B2/5)
Fault memory and activation of Check Engine (MIL)	At end of test duration and fault, two in sequence driving-cycles with faults
Test frequency	Continuously
Tested signal or condition	Limit values, IAT sensor
Lower threshold limit	> 300k Ω (approx. -50°C)
Upper threshold limit	< 92 Ω (approx. +150°C)
Test duration	approx. 1 sec.
Hint	With faults, the reserve value of +20°C is used. Should the signal become plausible, the signal from the IAT is subsequently used again.



Diagnosis – Diagnostic Trouble Code (DTC) Memory

DTC P0115	ECT sensor (B11/4)
Fault memory and activation of Check Engine (MIL)	At end of test duration and fault, two in sequence driving-cycles with faults
Test frequency, test duration	Continuously
Tested signal or condition	Limit values, ECT sensor (B11/4)
Lower threshold limit Upper threshold limit Plausibility	> 80 k Ω (approx. - 39°C) < 45 Ω (approx. +170°C) The temperature raise is compared to a stored baseline value. Independent of start temperature and engine rpm, a value of +15°C after 120-1200 sec. must be attained.
	With faults, the reserve value from the temperature base value is used. Should the signal become plausible, the signal from the ECT sensor is subsequently used again.

Diagnosis – Diagnostic Trouble Code (DTC) Memory

DTC P0120	Actual values-potentiometer in EA/CC/ISC actuator (M16/1)
Fault memory and activation of Check Engine (MIL)	At end of test duration and fault, two in sequence driving-cycles with faults
Test frequency	Continuously
Tested signal or condition	Voltage supply, Actual values-potentiometer 1 or 2
Actual values potentiometer 1	Voltage must be between 0.275 V and 4.83 V
Actual values potentiometer 2	Voltage must be between 0.176 V and 4.74 V

Diagnosis – Diagnostic Trouble Code (DTC) Memory

DTC P0130 DTC P0136 DTC P0140 DTC P0150 DTC P0156 DTC P0160	Right O2S 1 (before TWC) Right O2S 2 (after TWC) (only USA) Right O2S 1 (before TWC) Left O2S 2 (before TWC) Left O2S 2 (after TWC) (only USA) Left O2S 1 (before TWC)
Fault memory and activation of Check Engine (MIL)	At end of test duration and fault, two in sequence driving-cycles with faults
Test frequency	Continuously
Tested signal or condition	A. Limit values, O2 sensor signal B. Sensor status exchange
A. O2 sensor limit value signal Lower threshold limit value Upper threshold limit Test duration B. Sensor status exchange	<-0.15V > 1.5 V approx. 5 sec. With O2 heater on (approx. 220sec.), the sensor signal does not remain in the voltage window (0.4-0.6V) for longer than 15 seconds.
Test pre-requisites	– engine rpm approx. 1000-2000 – engine load approx. 15-50% – catalytic converter temperature > 380°C – release Lambda regulation
 Also see: 11/78	Via testing, all electrical connection faults of the O2 sensors before and after the catalytic converters are recognized (harness open circuits and shorts/high ohmic values/shorts to ground or positive). • The O2 sensor signal wire has a high ohmic short circuit or limited voltage increase. • The O2 sensor signal wire has an open circuit. With a cold O2 sensor: a high ohmic short circuit to positive or a short to ground on control module ME  If the O2 sensor signal wire ground is shorted to positive, the control module ME will be destroyed.

Diagnosis – Diagnostic Trouble Code (DTC) Memory

DTC P0133	Right O2S 1 (before TWC)
DTC P0153	Left O2S 2 (before TWC)
Fault memory and activation of Check Engine (MIL)	At end of test duration and fault, two in sequence driving-cycles with faults
Test frequency	Continuously
Tested signal or condition	A. Correction factor exceeded B. Time period too long
A. correction factor exceeded B. Time period too long Test duration	approx. ± 1.2 sec. > 5 sec. (average value via 15 measurements) up to 190 sec.
Test pre-requisites	<ul style="list-style-type: none"> – engine rpm approx. 1000-2000 – engine load approx. 15-50% – catalytic converter temperature > 380°C – Lambda correction effective – no faults with effective function of catalytic converter – no faults with O2 sensor heating

continued.

Diagnosis – Diagnostic Trouble Code (DTC) Memory



<p>DTC P0133</p> <p>DTC P0153</p>	<p>Right O2S 1 (before TWC)</p> <p>Left O2S 2 (before TWC)</p>
<p>Test sequence</p>	<p>The engine control module determines the the mid value of Lambda. This value is compared to the stored value for optimal exhaust gas value. With numerous of excessive values, a correction value for the lambda regulation is determined. With the correction factor (value with a new O2 sensor approx 0) the aging of the O2 sensor before the catalytic converter is equalized within certain limits. With exceeded values beyond the correction values, the O2 sensor before the catalytic converter must be replaced. Additionally, the timespan of the sensor before the catalytic converter is evaluated. If there is no O2 sensor condition interexchange, then the lambda regulation is not active and the two sensor regulation will not take place. With the O2 sensor signals after the catalytic converter, the effectiveness of the catalytic converter is monitored.</p>
<p> Also see: 11/79</p>	<p>Time span for O2 sensor before catalytic converter too long: O2 sensor located after the catalytic converter is no longer monitored.</p> <p>Correction factor of the O2 sensor before the catalytic converter exceeded: the O2 sensor after the catalytic converter is to be further monitored.</p> <p>If a fault is for both the O2 sensor before and after the catalytic converter is recorded, then usually the O2 sensor behind the catalytic converter is faulty.</p>

DTC P0135	Right O2S 1 (before TWC)
DTC P0141	Right O2S 2 (after TWC)
DTC P0155	Left O2S 2 (before TWC)
DTC P0161	Left O2S 2 (after TWC)
Fault memory and activation of Check Engine (MIL)	At end of test duration and fault, two in sequence driving-cycles with faults
Test frequency	Continuously
Tested signal or condition	Calculated resistance value of the O2 sensor heating
Lower threshold limit Upper threshold limit	< 2.0 Ω (approx. 6 A at 12 V) > 10 Ω (approx. 1.2 A at 12 V) Fault code is also set, if the time period of the O2 sensors suddenly exceeds 25 seconds within a driving-cycle.
Test pre-requisites	Engine running, O2 sensor heating ON and a heating time of 220 sec. has elapsed.

Diagnosis – Diagnostic Trouble Code (DTC) Memory

DTC P0170	Right cylinder bank
DTC P0173	Left cylinder bank
Fault memory and activation of Check Engine (MIL)	At end of test duration and fault, activation of Check Engine (MIL), after two in sequence driving-cycles with faults
Test frequency	Continuously
Tested signal or condition	Limit values of self adaption of mixture formation
A. Limit threshold value for idle B. Limit threshold value for part load	approx. \pm 1.0 ms (approx. 25% of injection time at idle) 0.7-1.3 factor
 Also see: 11/80	For the self adaption of the mixture formation to attain a new value, a drive time of approx. 30 minutes with lambda regulation is required. The coolant temperature at time of start must be < 60°C.

Diagnosis – Diagnostic Trouble Code (DTC) Memory

DTC P0201	Injector 1 (Y62y1)
DTC P0202	Injector 2 (Y62y2)
DTC P0203	Injector 3 (Y62y3)
DTC P0204	Injector 4 (Y62y4)
DTC P0205	Injector 5 (Y62y5)
DTC P0206	Injector 6 (Y62y6)
Fault memory and activation of Check Engine (MIL)	At end of test duration and fault, two in sequence driving-cycles with faults
Test frequency	Continuously
Tested signal or condition	Voltage and amp supply to each individual injector
Test requirements: Battery voltage between 8 - 17 V	Voltage and amp supply to each individual injector
Limit threshold value: short to positive	> 4.2A
Limit threshold value: short to ground	< 2.5 V
Wire has open circuit	no voltage at injector, approx. 4 - 8 volts at load free output of the engine control module ME
Test duration	approx. 1 sec.
	The activation of each individual injector is checked for harness opens and shorts to ground or positive. Shorts to ground and open circuits are recognized with a locked endstage, where else a short to positive is recognized with a conducting endstage. With a fault detected, the endstage is immediately no longer activated.
	With a short to ground, the individual injector remains continuously open.

Diagnosis – Diagnostic Trouble Code (DTC) Memory

DTC P0300	Random misfire
DTC P0301	Misfire, cyl. 1
DTC P0302	Misfire, cyl. 2
DTC P0303	Misfire, cyl. 3
DTC P0304	Misfire, cyl. 4
DTC P0305	Misfire, cyl. 5
DTC P0306	Misfire, cyl. 6
DTC P0460	Fuel level in fuel tank too low
DTC P0462	Fuel level in fuel tank too low
Fault memory and activation of Check Engine (MIL)	At end of test duration and fault, activation of Check Engine (MIL), after two in sequence driving-cycles with faults A. Misfire (emissions limit) Activation of Check Engine (MIL), after two in sequence driving-cycles with faults B. TWC damaging Activation of Check Engine (MIL), immediately upon misfiring
Test frequency	Continuously
Tested signal or condition	Count of recognized combustion misfires (recognition via uneven running engine evaluation)
Limit threshold values:	A. max. 20 combustion misfires within 1000 engine revolutions B. max. 4-35 combustion misfires within 200 engine revolutions (ECM map dependent of engine rpm and load i.e. 4 misfires at medium engine rpm and load, 35 misfires at idle w/o load)

Continued

Diagnosis – Diagnostic Trouble Code (DTC) Memory

DTC P0300	Random misfire
DTC P0301	Misfire, cyl. 1
DTC P0302	Misfire, cyl. 2
DTC P0303	Misfire, cyl. 3
DTC P0304	Misfire, cyl. 4
DTC P0305	Misfire, cyl. 5
DTC P0306	Misfire, cyl. 6
DTC P0460	Fuel level in fuel tank too low
DTC P0462	Fuel level in fuel tank too low
Test pre-requisites	<ul style="list-style-type: none"> – engine rpm approx. 450-6000 rpm – engine rpm variation less than 1900/rpm per sec. – engine load variation < 50% per second – engine start undertaken less then 5 seconds ago – no ESP interaction – CKP sensor adaption in coast range has been accomplished – no rough road conditions recognized (via CAN from ASR/ESP control modules, attained via comarison of VSS signals) – no faults from camshaft Hall-effect sensor (B6/1) – no injector shutoff

Continued

Diagnosis – Diagnostic Trouble Code (DTC) Memory

DTC P0300	Random misfire
DTC P0301	Misfire, cyl. 1
DTC P0302	Misfire, cyl. 2
DTC P0303	Misfire, cyl. 3
DTC P0304	Misfire, cyl. 4
DTC P0305	Misfire, cyl. 5
DTC P0306	Misfire, cyl. 6
DTC P0460	Fuel level in fuel tank too low
DTC P0462	Fuel level in fuel tank too low
i	<p>If too many misfires occur in one cylinder, then that cylinder will be turned off (cylinder selective fuel shut-off).</p> <p>Misfire due to ignition system faults: If ignition does not occur, misfires will result. If there are faults stored in the ignition system, in addition to the misfire, start at the ignition system first. Max. rough running per cylinder is 3m² if this value is exceeded, then proceed as follows:</p> <ol style="list-style-type: none"> 1. turn off one of the ignition circuits, using the SDS/HHT 2. Observe rough running of the affected cylinder: if the value has changed very little, (up to approx. 2m², then the remaining ignition circuit is OK. If the value has changed considerably, (beyond 2m² then the activated ignition circuit has a fault: spark plug, ignition lead or ignition coil. <p>Misfire due to fuel starvation: With recognized misfires, with a low fuel level in the fuel tank the DTC codes P0460 and P0462 are set, thus this information indicates a misfire due to low fuel level in fuel tank.</p> <p>Misfire due to additional causes: Misfires can be caused by the fuel injection system, additional faults may be stored, mechanical faults of the engine must be considered as well.</p>

Diagnosis – Diagnostic Trouble Code (DTC) Memory

DTC P0325	Right KS (A16g1)
DTC P0330	Left KS (A16g2)
Fault memory and activation of Check Engine (MIL)	Fault is immediately stored in memory Check Engine (MIL) is not activated
Test frequency	Continuously
Tested signal or condition	Knock sensor signal (in control module determined comparison via amplitude)
Lower threshold limit	approx. 0.10V
Upper threshold limit	approx. 4.98V
Test pre-requisites	<ul style="list-style-type: none"> – engine at operating temperature – engine rpm > 2000/rpm – engine load > 40% – knock regulation not active
	With faults, a safety ignition timing retard setting on all cylinders.

Diagnosis – Diagnostic Trouble Code (DTC) Memory

DTC P0335	CKP sensor signal (L5)
Fault memory and activation of Check Engine (MIL)	Two in sequence driving-cycles with faults
Test frequency	Continuously
Tested signal or condition	CKP sensor (L5) signal (flywheel tooth count)
Lower threshold limit	(60 -2 teeth) - 1 tooth
Upper threshold limit	60 -2 teeth) + 1 tooth
Test duration	aprox. 5 sec.

DTC P0341	CMP sensor signal (B6/1)
Fault memory and activation of Check Engine (MIL)	At end of test duration and fault, two in sequence driving-cycles with faults
Test frequency	Continuously
Tested signal or condition	CMP sensor (B6/1)
Plausibility	<p>No signal: within 2 engine revolutions, the signal must change from 0 to 1 and from 1 to 0</p> <p>Count: max. of 1 signal changeover (1 to 0 and 0 to 1) per engine revolution.</p>
Test pre-requisites	<p>engine rpm 25 - 600</p> <p>no faults from CKP sensor (L5).</p>
	To minimize damage to the catalytic converter, a missing signal from the Hall sensor or improper synchronization, results in fuel shutoff.

Diagnosis – Diagnostic Trouble Code (DTC) Memory

DTC P0400	EGR valve vacuum transducer (Y31/1)
Fault memory and activation of Check Engine (MIL)	At end of test duration and fault, two in sequence driving-cycles with faults
Test frequency	One per drive
Tested signal or condition	Intake manifold pressure
Limit threshold value Test duration	Vacuum in manifold must decrease by 54 mbar when exhaust gas recirculation flow is active approx. 2 sec.
Test pre-requisites	<ul style="list-style-type: none"> – no fault from EGR valve vacuum transducer (Y31/1) – no fault from pressure sensor (B28) – injector shut off is active – engine rpm approx. 900-1700 and constant – vehicle altitude location is under 8000 ft
	If the requirement are met, then the intake manifold pressure is measured and subsequently the exhaust gas recirculation is briefly activated.

Diagnosis – Diagnostic Trouble Code (DTC) Memory

DTC P0410	Air injection system
Fault memory and activation of Check Engine (MIL)	At end of test duration and fault, two in sequence driving-cycles with faults
Test frequency	Once per driving cycle.
Tested signal or condition	Lambda regulation
Limit threshold value	Lambda regulation factor approx. +23% ("rich" - detent stop)
Test duration	approx. 10 sec.
Test pre-requisites	<ul style="list-style-type: none"> – engine at idle – vehicle stationary – air injection pump has been activated 1x after engine start – no faults with voltage supply to exhaust gas recirculation valve (Y31/1), air pump switchover valve (Y32) and electrical air pump (M33) – no faults with exhaust gas recirculation system – no faults with throttle setting element (M16/6) – no combustion misfires – no faults with O2 sensor before catalytic converter, aging – no faults with CAN Databus – self adaption of mixture formation not at limit values – outside air pressure over approx. 780 hPa (since the test will not be done above 8000 ft) – engine coolant temperature < 90°C – Lambda regulation released – A/C is off

Continued

Diagnosis – Diagnostic Trouble Code (DTC) Memory

DTC P0410	Air injection system
Test sequence	With the start of the logic chain, all functions for the self adaption of the mixture formation are locked. The exhaust gas recirculation valves are closed and the current lambda regulation factor is attained. Thereafter air injection follows. The mixture must lean out. As a result the lambda regulation factor reacts with an increase of approx. 23%.
	If the requirements change during the test, the test is as a result stopped and is later restarted again.

Diagnosis – Diagnostic Trouble Code (DTC) Memory

DTC P0422	TWC right efficiency
DTC P0432	TWC left efficiency
Fault memory and activation of Check Engine (MIL)	At end of test duration and fault, two in sequence driving-cycles with faults
Test frequency	Continuously
Tested signal or condition	Voltage relationship (amplitudes) between sensors before catalytic converters and sensors after catalytic converters
Limit threshold value	O2 sensor signal after catalytic converter is max. 75% of O2 sensor signal before catalytic converter
Test duration	approx. 170 sec.
Test pre-requisites	<ul style="list-style-type: none"> – engine rpm 1000-2700 – engine load approx. 22% to 52% – catalytic converter temperature > 380°C – lambda regulation released and lambda > 0.4 – no faults with O2 sensors (signal, heating, aging) – no combustion misfires

Continued.

Diagnosis – Diagnostic Trouble Code (DTC) Memory

DTC P0422 DTC P0432	TWC left efficiency (continued) TWC right efficiency
 Also see: 11/81	<p>The catalytic converter is evaluated for its oxygen storing capability. Within the required engine rpm and load ranges many measurements need to be accomplished. The results are compared to a map and from that faults are recognized. The amplitude of the O2 sensors after the catalytic converters must be smaller than the amplitude of the O2 sensors before the catalytic converters. (Hint; if for example, a monolith was left out within the catalytic converter, then the O2 sensors signals both before and after the catalytic converters would be identical).</p> <p>If the fault codes for the catalytic converter and the O2 sensor before stored at the same time, then replace the O2 sensor before the catalytic converter first. If thereafter, no more catalytic converter fault is present, then the catalytic converter is slightly reduced in effectiveness, but does not need to be replaced.</p>

Diagnosis – Diagnostic Trouble Code (DTC) Memory

DTC P0440	Evap. system malfunction (leak)
DTC P0441	Purge control valve (function)
DTC P0442	Evap. system leak (small)
DTC P0455	Evap. system leak (large)
Fault memory Activation of Check Engine (MIL) or motor diagnostics	After completion of test cycle time period and faults Two in sequence driving-cycles with faults
Test frequency	Once per drive-cycle
Tested signal or condition	Pressure values per fuel tank pressure sensor (B4/3)
Large leak test Small leak test Test duration	Vacuum of approx. 0.4 mbar per second is not attained. Loss of vacuum within closed system is 15% greater the achieved vacuum values during the large leak test above. approx. 30 sec

Continued.

Diagnosis – Diagnostic Trouble Code (DTC) Memory

DTC P0440	Evap. system malfunction (leak)
DTC P0441	Purge control valve (function)
DTC P0442	Evap. system leak (small)
DTC P0455	Evap. system leak (large)
Test pre-requisites	<ul style="list-style-type: none"> – engine at idle – vehicle stationary – lock time of approx. 16 min. after engine start has elapsed or fuel mixture adaption occurs. – lambda regulation released – air injection is not active – outside air pressure over approx. 780 hPa (since the test will not be done above 8000 ft) – little saturation of activated charcoal cannister – lambda is > 0.9 during the testing – with a fuel tank level of <1/4 and > 3/4 only the large leak test is undertaken – if the fuel within the fuel tank sloshes greatly (large pressure variations), the fuel tank pressure sensor (B4/3) recognizes same and stops the test. – no fault at activated charcoal cannisters shut-off valve (Y58/4) – no fault at fuel tank pressure sensor (B4/3) – no fault with fuel level sensor – no fault with purge valve (Y58/1) function (open/close)
	The DTC P0455 is stored in memory, if the fuel tank pressure sensor (B4/3) is defective.

Diagnosis – Diagnostic Trouble Code (DTC) Memory

Evaporative System
 Engine 119 shown without On-board
 Refueling Vapor Recovery

The leak test for the EVAP system must detect leaks of 1mm in diameter. By law no fuel vapors are to be admitted to atmosphere.

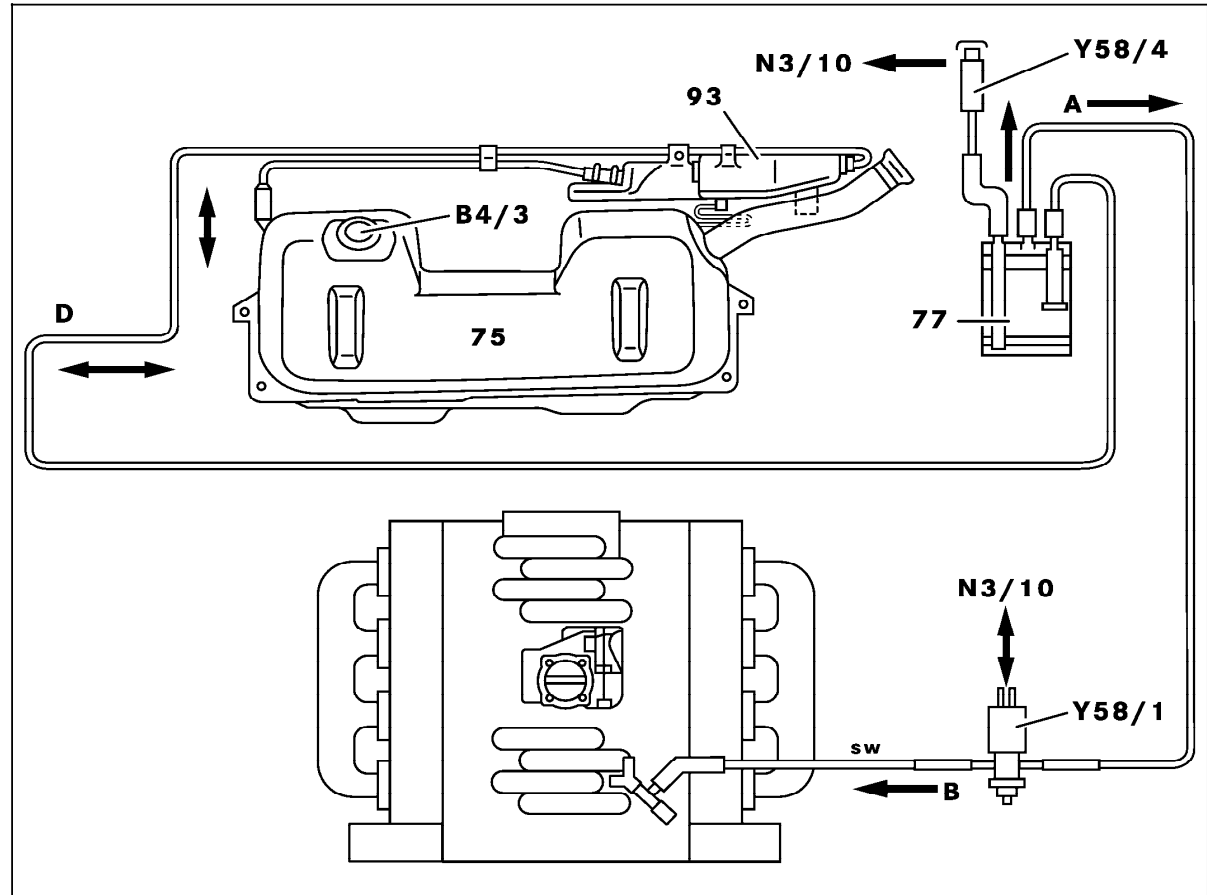

Figure 1

- 75 Fuel tank
- 77 Activated charcoal cannister
- 93 Fuel tank expansion reservoir
- A Activated charcoal cannister to purge valve hose
- B Purge valve to intake manifold hose
- D Fuel tank to activated charcoal cannister hose
- B4/3 Fuel tank pressure sensor
- N3/10 Engine control module (ME-SFI)
- Y58/1 Purge control valve
- Y58/4 Activated charcoal canister shut-off valve

P47.30-0284-06

Function

The leak test (logic chain) is accomplished in two phases:

- Large leak test
- Small leak test

Continued...

Diagnosis – Diagnostic Trouble Code (DTC) Memory

Function (continued)

1. Large leak test

The activated charcoal cannister shut-off valve (Y58/4) is closed and the purge valve (Y58/1) is opened. As a result, the intake manifold vacuum reaches the fuel tank and is evaluated by the fuel tank pressure sensor (B4/3).

If no vacuum is established (i.e. approx. -4mbar within 10 seconds) a large leak is present (fuel tank cap open, loose hose connection etc.).



If the engine control module (N3/10) recognizes a large leak within the fuel system, the fuel reserve indicator lamp (A1e4) in the instrument cluster will blink as a result.

2. Small leak test

If the large leak test results in no fault then a small leak test is performed. Once a vacuum of -7mbar is achieved, the purge control valve (Y58/1) is closed and the vacuum is evaluated for an additional 30 seconds.

The vacuum must remain constant during this time period. Should a leak be detected, then a fault is recognized.

After the test, the activated charcoal cannister shut-off valve (Y58/4) is opened.

The purge control valve (Y58/1) is checked for proper function via activation at the same time.

Diagnosis – Diagnostic Trouble Code (DTC) Memory

DTC P0443	Purge control valve (Y58/1)
Fault memory and activation of Check Engine (MIL)	At end of test duration and fault, two in sequence driving-cycles with faults
Test frequency	Continuously
Tested signal or condition	Voltage or amps at purge control valve (Y58/1)
Limit threshold values	Short to ground Voltage < 4 V Short to positive Amps > 4.2 A Open circuit No voltage at purge control valve (approx. 4-8 V at output stage).
Test duration	approx. 1 second
	The activation of the purge control valve is checked for harness opens and shorts to ground or positive. Shorts to ground and open circuits are recognized with a locked endstage, where else a short to positive is recognized with a conducting endstage. With a fault detected, the endstage is immediately no longer activated.

Diagnosis – Diagnostic Trouble Code (DTC) Memory

DTC P0446	Activated charcoal cannister shut-off valve (Y58/4)
Fault memory and activation of Check Engine (MIL)	At end of test duration and fault, two in sequence driving-cycles with faults
Test frequency	Continuously
Tested signal or condition	Voltage supply at activated charcoal cannister shut-off valve (Y58/4)
Limit threshold values, voltage supply	
Short to ground	Voltage < 4 V
Short to positive	Amps > 4.2 A
Open circuit	No voltage at activated charcoal cannister shut-off valve (approx. 4-8 V) at output stage.
	The activation of the activated charcoal cannister shut-off valve is checked for harness opens and shorts to ground or positive. Shorts to ground and open circuits are recognized with a locked endstage, where else a short to positive is recognized with a conducting endstage. With a fault detected, the endstage is immediately no longer activated.

Diagnosis – Diagnostic Trouble Code (DTC) Memory

DTC P0450	Fuel tank pressure sensor (B4/3)
Fault memory and activation of Check Engine (MIL)	At end of test duration and fault, two in sequence driving-cycles with faults
Test frequency	Once per driving-cycle
Tested signal or condition	Fuel tank pressure sensor (B4/3) electrical fault Fuel tank pressure sensor (B4/3) signal fluctuations
A Lower threshold limit Upper threshold limit Test duration	> 4.7 V (relates to approx. 35 mbar positive pressure) < 0.1 V (relates to approx. -60 mbar vacuum) approx. 10 sec.
B Signal sequence	The fuel tank pressure, with active recirculation can pulsate at max. 2 mbar (0.1 V), otherwise the activated charcoal cannister maybe plugged.
Test pre-requisites	– engine at idle
	the test is run independent of the evap. system leak test The sensor is tested for an electrical fault (short circuit, short to ground or positive). If the sensor voltage is below or above values, a fault is present. Base line for fuel tank pressure sensor: -50 mbar approx. 0.5 V; 0 mbar approx. 3.0 V; +30 mbar approx. 4.5 V. If the sensor is "hung", a constant signal yet plausible signal can be present. In this case, a large leak will be present in the evap. system.

Diagnosis – Diagnostic Trouble Code (DTC) Memory

DTC P0500	VSS signal
Fault memory and activation of Check Engine (MIL)	At end of test duration and fault, two in sequence driving-cycles with faults, stored in DTC memory Check Engine (MIL) is not activated (illuminated)
Test frequency	Continuously
Tested signal or condition	A VSS signal left front B VSS signal left rear
Limit threshold values Test duration	After approx. 8 miles per hr vehicle speed, the VSS signals must be recognized approx. 5 sec.
Plausibility Test duration	Requirement after approx. 25 miles per hr vehicle speed: VSS front minus VSS rear < ± 18 miles per hr approx. 30 sec.
Test pre-requisites	– engine rpm approx. 2500-4500 – engine load > 40% – transmission selector lever in D
	The wheel speed (VSS signal) is recognized and evaluated via the ASR or ESP control module (G-wagen ABS). The ME-SFI control module receives the VSS signal via the CAN databus. Readout DTC memory (i.e. driving on dynamometer) for ME-SFI and ASR or ME-SFI and ESP control modules.

Diagnosis – Diagnostic Trouble Code (DTC) Memory

DTC P0507	ISC control system unplausible
Fault memory and activation of Check Engine (MIL)	At end of test duration and fault, two in sequence driving-cycles with faults
Test frequency	Continuously
Tested signal or condition	Engine rpm
Upper threshold limit value Lower threshold limit test duration	Nominal value + 200 rpm Nominal value - 100 rpm approx. 30 sec. If the activation of the actuator motor within actuator (via the ME control module) is performed, then the new value must be attained within 25 sec.
Test pre-requisites	<ul style="list-style-type: none"> – Engine temperature > 20° C – Climate control system: OFF – Vehicle stationary

Diagnosis – Diagnostic Trouble Code (DTC) Memory

DTC P0560	Battery voltage at ME-SFI control module
Fault memory and activation of Check Engine (MIL)	At end of test duration and fault, two in sequence driving-cycles with faults
Test frequency	Continuously
Tested signal or condition	Battery voltage at the control module ME
Limit threshold value	Voltage must be between approx. 8 V and 17.5 V
Test duration	approx. 5 sec.
Test pre-requisites	– Time period of 180 sec. has elapsed since start

Diagnosis – Diagnostic Trouble Code (DTC) Memory

DTC P0600	CAN bus from ASR/ESP control module (not on G-Wagen)
DTC P1747	CAN bus from ETC or instrument cluster
Fault memory and activation of Check Engine (MIL)	At end of test duration and fault, two in sequence driving-cycles with faults
Test frequency	Continuously
Tested signal or condition	CAN communication
Test duration	approx. 15 sec.
 Also see: 11/82	The data transmission between the control modules is monitored via the CAN controller within the ME-SFI control module.

Diagnosis – Diagnostic Trouble Code (DTC) Memory

DTC P0700	Transmission control system malf. (gear ratio unplausible, transmission leak)								
Fault memory and activation of Check Engine (MIL)	At end of test duration and fault, two in sequence driving-cycles with faults								
Monitor time and test frequency	Continuously								
Tested signal or condition	Calculated gear ratios relationship out of tolerance								
Acceptable gear ratios	<table border="0"> <tr> <td>-0.20 to 0.20</td> <td>1st and 2nd gear</td> </tr> <tr> <td>-0.05 to 0.050</td> <td>3rd gear</td> </tr> <tr> <td>-0.03 to 0.030</td> <td>4th and 5th gear</td> </tr> <tr> <td>-0.2 to 0.20</td> <td>Reverse gear</td> </tr> </table>	-0.20 to 0.20	1st and 2nd gear	-0.05 to 0.050	3rd gear	-0.03 to 0.030	4th and 5th gear	-0.2 to 0.20	Reverse gear
-0.20 to 0.20	1st and 2nd gear								
-0.05 to 0.050	3rd gear								
-0.03 to 0.030	4th and 5th gear								
-0.2 to 0.20	Reverse gear								
Test duration	approx. 2 sec.								
Test pre-requisites	<ul style="list-style-type: none"> - engine rpm > 400 - output shaft rpm > 180rpm (12 miles per hr) - no shift undertaken 								
Test sequence	If there is no shift undertaken, then the ETC control module recognizes the gear ratio relationship for the gear in use. If the acceptable gear ratio is out of tolerance or the gear recognition is unplausible, then the modulator pressure is adjusted to its highest value after approx. 5 seconds. Should the gear ratio remain out of tolerance or the gear recognition is unplausible then after 1 second a DTC is stored.								
	The calculated gear ratios are calculated from the following values: N2 rpm, N3 rpm and outputshaft rpm (via rear wheel VSS). Faults are noted by the ETC control module and sent via CAN data bus to the ME-SFI control module. DTC storage and activation of the CHECK ENGINE (MIL) occur via the ME-SFI control module. Readout additional DTC 51 from ETC control module.								

Diagnosis – Diagnostic Trouble Code (DTC) Memory

DTC P0700	Command valve sticks in pressure position								
Fault memory and activation of Check Engine (MIL)	At end of test duration and fault, two in sequence driving-cycles with faults								
Test frequency	Continuously								
Tested signal or condition	Calculated gear ratio relationship out of tolerance								
Acceptable gear ratios	<table border="0"> <tr> <td>-0.20 to 0.20</td> <td>1st and 2nd gear</td> </tr> <tr> <td>-0.05 to 0.050</td> <td>3rd gear</td> </tr> <tr> <td>-0.03 to 0.030</td> <td>4th and 5th gear</td> </tr> <tr> <td>-0.2 to 0.20</td> <td>Reverse gear</td> </tr> </table>	-0.20 to 0.20	1st and 2nd gear	-0.05 to 0.050	3rd gear	-0.03 to 0.030	4th and 5th gear	-0.2 to 0.20	Reverse gear
-0.20 to 0.20	1st and 2nd gear								
-0.05 to 0.050	3rd gear								
-0.03 to 0.030	4th and 5th gear								
-0.2 to 0.20	Reverse gear								
Test duration	approx. 2 sec.								
Test pre-requisites	<ul style="list-style-type: none"> - engine rpm > 400 - output shaft rpm > 180 rpm (12 miles per hr) - no shift undertaken 								
Test sequence	After each shift procedure, the shift pressure is reduced gradually. If the activated shift components drag after the pressure reduction, the command valve will bind in the shift phase (pressure) side. Shift components which drag will be recognized via the gear ratio relationship tolerances								
	The calculated gear ratios are calculated from the following values: N2 rpm, N3 rpm and outputshaft rpm (via rear wheel VSS). Faults are noted by the ETC control module and sent via CAN data bus to the ME-SFI control module. DTC storage and activation of the CHECK ENGINE (MIL) occur via the ME-SFI control module. Readout additional DTC 51, 52 from ETC control module.								

Diagnosis – Diagnostic Trouble Code (DTC) Memory

DTC P0702	Transmission control system malf. (electrical)
Fault memory and activation of Check Engine (MIL)	At end of test duration and fault, two in sequence driving-cycles with faults
Test frequency	Continuously
Tested signal or condition	Faults within ETC control module – CAN data bus communication – Unacceptable version coding – Internal memory (RAM, ROM, EEPROM)
	Faults are recognized via the ETC control module and are sent via the CAN data bus to the ME-SFI control module. DTC memory and activation of the CHECK ENGINE MIL are done via the ME-SFI control module. Readout additional DTCs 5B–55 in ETC control module.

Diagnosis – Diagnostic Trouble Code (DTC) Memory

DTC P0102	Voltage supply to solenoid valves
Fault memory and activation of Check Engine (MIL)	At end of test duration and fault, two in sequence driving-cycles with faults
Test frequency	Continuously
Tested signal or condition	Voltage supply to solenoid valves
Lower threshold limit value	approx. 8.5 V (longer then approx. 0.1 sec.)
Upper threshold limit value	approx. 15 V (longer then approx. 0.1 sec.)
Test sequence	The solenoid valves are supplied battery voltage via the ETC control module. The difference in value between battery voltage and supplied battery voltage to the solenoid valves is monitored by the ETC control module.
	Faults are recognized via the ETC control module and are sent via the CAN data bus to the ME-SFI control module. DTC memory and activation of the CHECK ENGINE MIL are done via the ME-SFI control module. Readout additional DTC ID in ETC control module.

Diagnosis – Diagnostic Trouble Code (DTC) Memory

DTC P0715	RPM sensor function, voltage supply
Fault memory and activation of Check Engine (MIL)	At end of test duration and fault, two in sequence driving-cycles with faults
Test frequency	Continuously
Tested signal or condition	<ul style="list-style-type: none"> – RPM sensor voltage supply – N2 rpm – N3 rpm
RPM sensor voltage supply Lower threshold limit value Upper threshold limit value N2, N3 rpm signals Test duration	< 4.8 V > 7.2 V Signals recognized and plausible approx. 1 sec.
Test pre-requisites N2 rpm sensor N3 rpm sensor	<ul style="list-style-type: none"> – engine rpm > 450 – right rear wheel rpm (VSS) > 250 – left rear wheel rpm (VSS) > 250 – 3rd or 4th gear recognized – output shaft rpm > 180 rpm (12 miles per hr) – no shift undertaken

Continued

Diagnosis – Diagnostic Trouble Code (DTC) Memory

DTC P0715	RPM sensor function, voltage supply
Test sequence	After a predetermined engine and wheel rpm, the rpm sensor signals must be recognized. For the N3 rpm signal, 3rd or 4th gear must be engaged.
	Faults are recognized via the ETC control module and are sent via the CAN data bus to the ME-SFI control module. DTC memory and activation of the CHECK ENGINE MIL are done via the ME-SFI control module. Readout additional DTC 11, 12, 13 in ETC control module.

Diagnosis – Diagnostic Trouble Code (DTC) Memory

DTC P0720	CAN fault recognition
Fault memory and activation of Check Engine (MIL)	At end of test duration and fault, two in sequence driving-cycles with faults
Test frequency	Continuously
Tested signal or condition	Wheel rpm (VSS) is checked for plausibility via ETC control module which receives the signal via the ASR and ESP control modules (G-wagen = ABS control module) via the CAN data bus
Test duration	approx. 1 sec.
	Faults are recognized via the ETC control module and are sent via the CAN data bus to the ME-SFI control module. DTC memory and activation of the CHECK ENGINE MIL are done via the ME-SFI control module. Readout additional DTC 22, 23, 3B in ETC control module.

Diagnosis – Diagnostic Trouble Code (DTC) Memory

DTC P0730	Incorrect gear ratio
Fault memory and activation of Check Engine (MIL)	At end of test duration and fault, two in sequence driving-cycles with faults
Test frequency	Continuously
Tested signal or condition	Comparison of known gear ratio and engaged gear (calculated gear ratio) is at least 6X negative
Test pre-requisites	<ul style="list-style-type: none"> – 2nd, 3rd, 4th or 5th gear recognized – engine rpm > 450 – output shaft rpm > 180 rpm (12 miles per hr) – no shift undertaken
	The calculated gear ratios are calculated from the following values: N2 rpm, N3 rpm and outputshaft rpm (via rear wheel VSS). Faults are noted by the ETC control module and sent via CAN data bus to the ME-SFI control module. DTC storage and activation of the CHECK ENGINE (MIL) occur via the ME-SFI control module. Readout additional DTC 55 from ETC control module.

Diagnosis – Diagnostic Trouble Code (DTC) Memory

DTC P0740	Torque converter lock-up clutch
Fault memory and activation of Check Engine (MIL)	At end of test duration and fault, two in sequence driving-cycles with faults
Test frequency	Continuously
Tested signal or condition	Friction value of torque converter lock-up clutch
Test sequence	The friction value is monitored via during torque converter lock-up by noting rpm differences. Should the values be out of tolerance numerous times, a DTC fault is noted.
	Faults are recognized via the ETC control module and are sent via the CAN data bus to the ME-SFI control module. DTC memory and activation of the CHECK ENGINE MIL are done via the ME-SFI control module. Readout additional DTC 53 in ETC control module.

Diagnosis – Diagnostic Trouble Code (DTC) Memory

DTC P0143	PWM solenoid valve (Y3/6y6)
Fault memory and activation of Check Engine (MIL)	At end of test duration and fault, two in sequence driving-cycles with faults
Test frequency	Continuously
Tested signal or condition	PWM solenoid valve engagement quality
Lower threshold limit value Upper threshold limit value	< 5 % > 94%
Test duration	1 sec.
	Faults are recognized via the ETC control module and are sent via the CAN data bus to the ME-SFI control module. DTC memory and activation of the CHECK ENGINE MIL are done via the ME-SFI control module. Readout additional DTC 5 in ETC control module.

Diagnosis – Diagnostic Trouble Code (DTC) Memory

DTC P0748	Modulating pressure regulating solenoid valve (Y3/6y1)
Fault memory and activation of Check Engine (MIL)	At end of test duration and fault, two in sequence driving-cycles with faults
Monitor time and test frequency	Continuously
Tested signal or condition	Activation of modulating pressure regulating solenoid valve
Limit values	
Short to ground	< 0.4 V
Lower threshold limit value, voltage	approx. 8.5 V
Upper threshold limit value, voltage	approx. 15 V
Lower threshold limit value, amps	approx. 0.300 A
Upper threshold limit value, amps	approx. 0.700 A
Test duration	1 sec.
	Faults (open circuit, short or short within solenoid while activating) are recognized via the ETC control module and are sent via the CAN data bus to the ME-SFI control module. DTC memory and activation of the CHECK ENGINE MIL are done via the ME-SFI control module. Readout additional DTC 5 in ETC control module.



Diagnosis – Diagnostic Trouble Code (DTC) Memory

DTC P0748	Shift pressure regulating solenoid valve (Y3/6y2)
Fault memory and activation of Check Engine (MIL)	At end of test duration and fault, two in sequence driving-cycles with faults
Test frequency	Continuously
Tested signal or condition	Activation of shift pressure regulating solenoid valve (Y3/6y2)
Limit values	
Short to ground	< 0.4 V
Lower threshold limit value, voltage	approx. 8.5 V
Upper threshold limit value, voltage	approx. 15 V
Lower threshold limit value, amps	approx. 0.300 A
Upper threshold limit value, amps	approx. 0.700 A
Test duration	1 sec.
	Faults (open circuit, short or short within solenoid while activating) are recognized via the ETC control module and are sent via the CAN data bus to the ME-SFI control module. DTC memory and activation of the CHECK ENGINE MIL are done via the ME-SFI control module. Readout additional DTC 7 in ETC control module.

Diagnosis – Diagnostic Trouble Code (DTC) Memory

DTC P0753	1-2/4-5shift solenoid valve (Y3/6y3)
Fault memory and activation of Check Engine (MIL)	At end of test duration and fault, two in sequence driving-cycles with faults
Test frequency	Continuously
Tested signal or condition	Voltage supply to 1-2/4-5shift solenoid valve (Y3/6y3)
Limit values Lower threshold limit value, voltage Upper threshold limit value, voltage Short to ground Lower threshold limit value, amps Upper threshold limit value, amps Test duration	approx. 8.5 V approx. 15 V < 0.4 V approx. 0.300 A approx. 0.700 A approx. 1 sec.
	Faults (open circuit, short or short within solenoid while activating) are recognized via the ETC control module and are sent via the CAN data bus to the ME-SFI control module. DTC memory and activation of the CHECK ENGINE MIL are done via the ME-SFI control module. Readout additional DTC 2 in ETC control module.

Diagnosis – Diagnostic Trouble Code (DTC) Memory

DTC P0758	2-3 shift solenoid valve (Y3/6y5)
Fault memory and activation of Check Engine (MIL)	At end of test duration and fault, two in sequence driving-cycles with faults
Test frequency	Continuously
Tested signal or condition	Voltage supply to 2-3 shift solenoid valve (Y3/6y5)
Limit values	
Lower threshold limit value, voltage	approx. 8.5 V
Upper threshold limit value, voltage	approx. 15 V
Short to ground	< 0.4 V
Lower threshold limit value, amps	approx. 0.300 A
Upper threshold limit value, amps	approx. 0.700 A
Test duration	approx. 1 sec.
	Faults (open circuit, short or short within solenoid while activating) are recognized via the ETC control module and are sent via the CAN data bus to the ME-SFI control module. DTC memory and activation of the CHECK ENGINE MIL are done via the ME-SFI control module. Readout additional DTC  in ETC control module.

Diagnosis – Diagnostic Trouble Code (DTC) Memory

DTC P0763	3-4 shift solenoid valve (Y6/3y4)
Fault memory and activation of Check Engine (MIL)	At end of test duration and fault, two in sequence driving-cycles with faults
Test frequency	Continuously
Tested signal or condition	Voltage supply to 3-4 shift solenoid valve (Y6/3y4)
Limit values Lower threshold limit value, voltage Upper threshold limit value, voltage Short to ground Lower threshold limit value, amps Upper threshold limit value, amps Test duration	approx. 8.5 V approx. 15 V < 0.4 V approx. 0.300 A approx. 0.700 A approx. 1 sec.
	Faults (open circuit, short or short within solenoid while activating) are recognized via the ETC control module and are sent via the CAN data bus to the ME-SFI control module. DTC memory and activation of the CHECK ENGINE MIL are done via the ME-SFI control module. Readout ETC control module.

Diagnosis – Diagnostic Trouble Code (DTC) Memory

DTC P1386	Knock sensor control in N3/10
Fault memory and activation of Check Engine (MIL)	At end of test duration and fault, fault is stored immediately Check Engine (MIL) is not activated (illuminated)
Test frequency	After each deactivation of the knock sensor control
Tested signal or condition	Hardware test of knock sensor control
Test pre-requisites	– engine at operating temperature – engine load is decreasing (deactivate knock sensor control)
	Fault must appear at least 10 times.

Diagnosis – Diagnostic Trouble Code (DTC) Memory

DTC P1400	EGR valve vacuum transducer (Y31/1)
Fault memory and activation of Check Engine (MIL)	At end of test duration and fault, two in sequence driving-cycles with faults
Test frequency	Continuously
Tested signal or condition	Voltage/amps to EGR valve vacuum transducer (Y31/1)
Limit threshold values	
Short to ground	approx. < 2.5 Volts
Short to positive (+12 V)	approx. > 4.2 Amps
Open circuit	no voltage at EGR valve vacuum transducer (approx. 4-8 V)
Test duration	approx. 1 sec
Test pre-requisites	Battery voltage must be between approx. 8 V and 17.1 V
	<p>Tested are shorts and open circuits (shorts to ground and to positive). Shorts to ground and open circuits are recognized with a locked endstage, where else a short to positive is recognized with a conducting endstage. With a fault the endstage is no longer activated.</p>

Diagnosis – Diagnostic Trouble Code (DTC) Memory

DTC P1420	AIR pump switchover valve (Y32)
DTC P1453	AIR relay module, AIR pump
Fault memory and activation of Check Engine (MIL)	At end of test duration and fault, two in sequence driving-cycles with faults
Test frequency	Continuously
Tested signal or condition	Via the amp measurement of each endstage, the voltage supply of the relay air pump in relay module (K40) and AIR pump switchover valve (Y32) is evaluated.
Limit threshold values	Air injection: OFF : max. of 3 volts are allowed at the output side. Air injection: ON : a min. of 9 volts must be at the output side.

Diagnosis – Diagnostic Trouble Code (DTC) Memory

DTC P1542	Pedal value sensor (B37)
Fault memory	At end of test duration and fault, two in sequence driving-cycles with faults, Check Engine (MIL) is not illuminated, fault is stored immediately.
Test frequency	Continuously
Tested signal or condition	Voltage signal 1 and 2 are compared (of potentiometers and Hall sensors).
Difference at idle Difference at full load Plausibility	< 8 % < 25 % comparison of signals 1 and 2 to air mass value
Test duration	approx. 30 sec.
Test pre-requisites	The "lock time" of 60 seconds after engine start has elapsed.
	A fault is stored if the voltage difference is greater than 8% (up to 60% turn angle of the pedal value sensor) or greater than 25% (as of 60% turn angle of the pedal value sensor). For comparison, the voltage signals 2 with 2 are multiplied. With the production start up of engine 112 and 113, a pedal sensor with Hall sensors has been phased in. If faults are noted, emergency run is activated.

Diagnosis – Diagnostic Trouble Code (DTC) Memory

DTC P1580	EA/CC/ISC actuator (M16/1)
Fault memory and activation of Check Engine (MIL)	At end of test duration and fault, two in sequence driving-cycles with faults
Test frequency	Continuously
Tested signal or condition	Voltage comparison of actual values potentiometer 1 and actual values potentiometer 2
Plausibility	<ul style="list-style-type: none">– Voltage difference can be up to 1° of the throttle plate angle.– Comparison of throttle plate angle and pedal value sensor position.

Diagnosis – Diagnostic Trouble Code (DTC) Memory

Figure 1

02 sensor voltage as shown on engine 137

G/3 Sensor signal sensitivity ok

X1 Connector

- 1 Circuit 78 Sensor heating
- 2 Sensor heating ground
- 3 Sensor signal ground
- 4 Sensor signal (approx. 0.45 V at $\lambda = 1$ and 02 sensor at operating temperature.

N3/10 control module ME

- 4X measurement amplifier for sensor signal and sensor ground evaluation switching
- 0.268 V opposite voltage based on ground circuit 31

Z6/4 Connector socket sensor signal ground
(4 02 sensors, engine 137 only)

Z7/36 Connector socket circuit 87

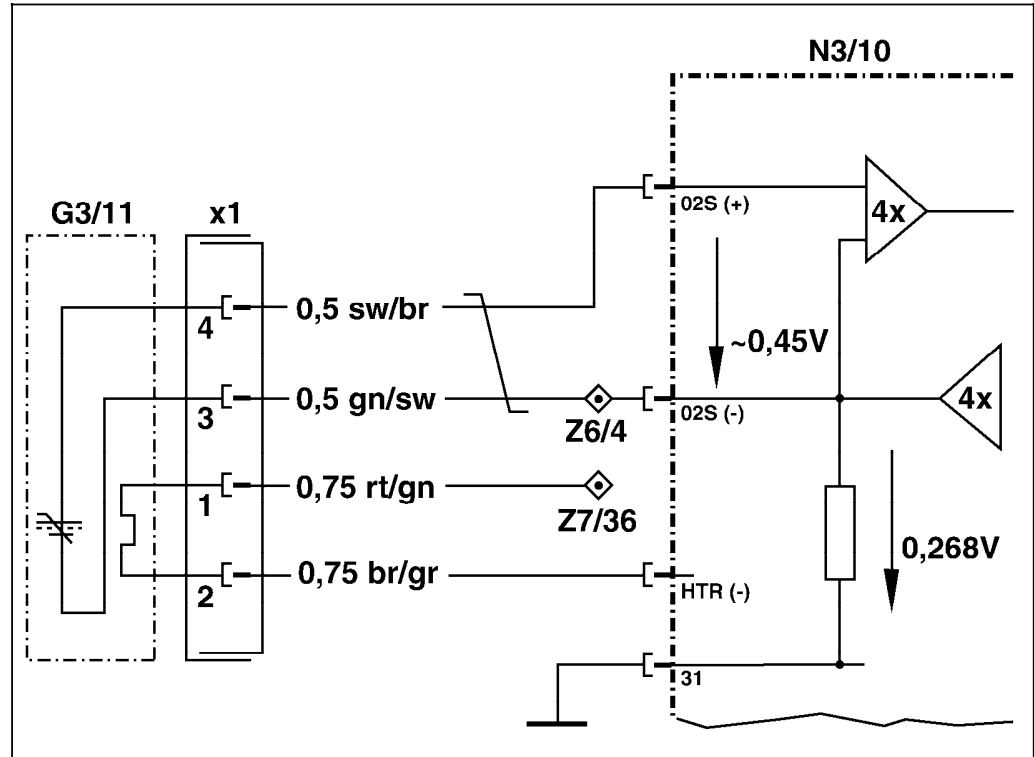

P07.61-2531-11

Diagnosis – Diagnostic Trouble Code (DTC) Memory

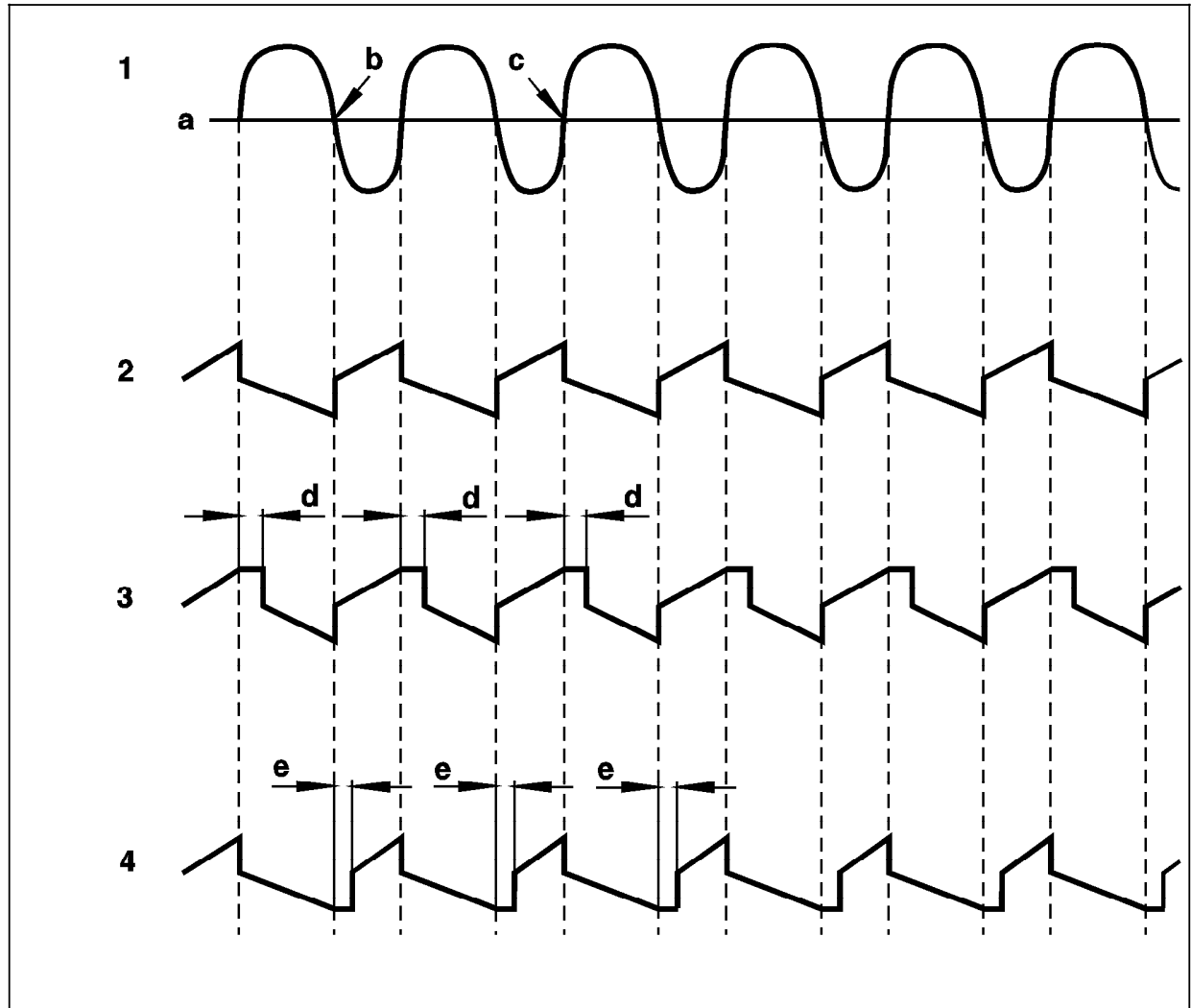

Figure 2
Two O2 sensor regulation

- 1 O2 sensor signal before CAT.
a Voltage peak for Rich - lean changeover (B) or Lean - rich changeover (c)
- 2 Lambda regulation without correction
- 3 Lambda regulation with correction (d), time delay (+TV) towards Rich
- 4 Lambda regulation with correction (e), time delay (+TV) towards Lean

P07.61-0383-06

Diagnosis – Diagnostic Trouble Code (DTC) Memory

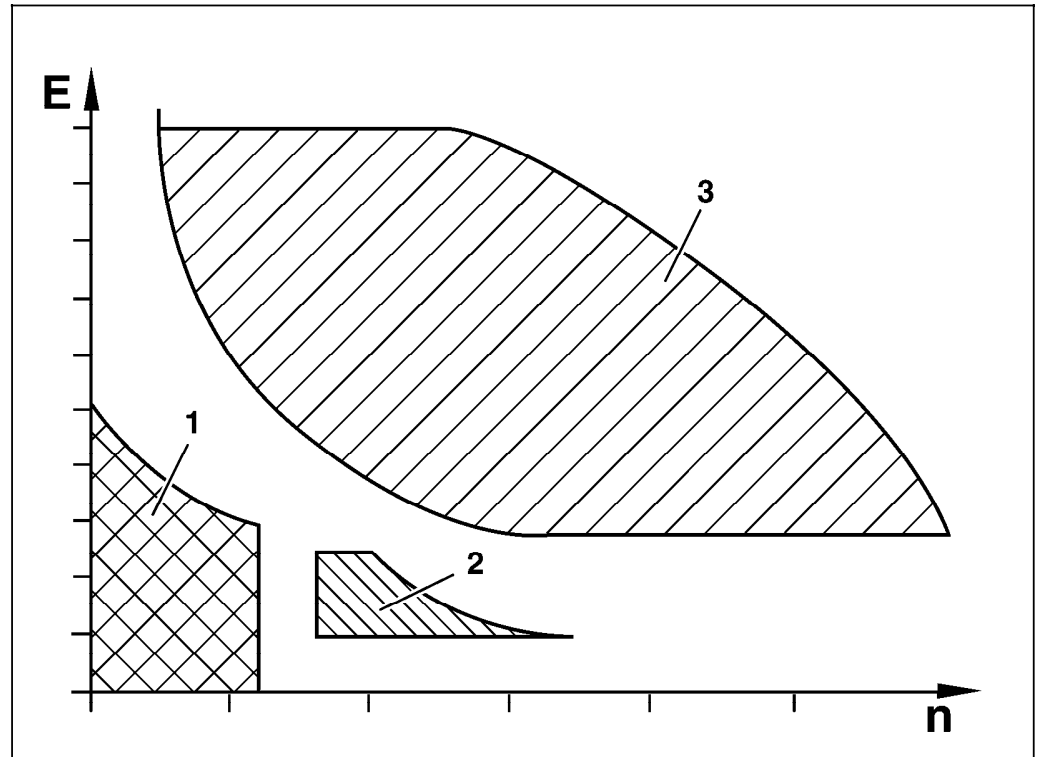

Figure 3
Fuel mixture - self adaption

- 1 Idle range
- 2 Range between idle and part load
- 3 Part load range

E Injection amount
n Engine rpm

P07.61-2529-11

Diagnosis – Diagnostic Trouble Code (DTC) Memory

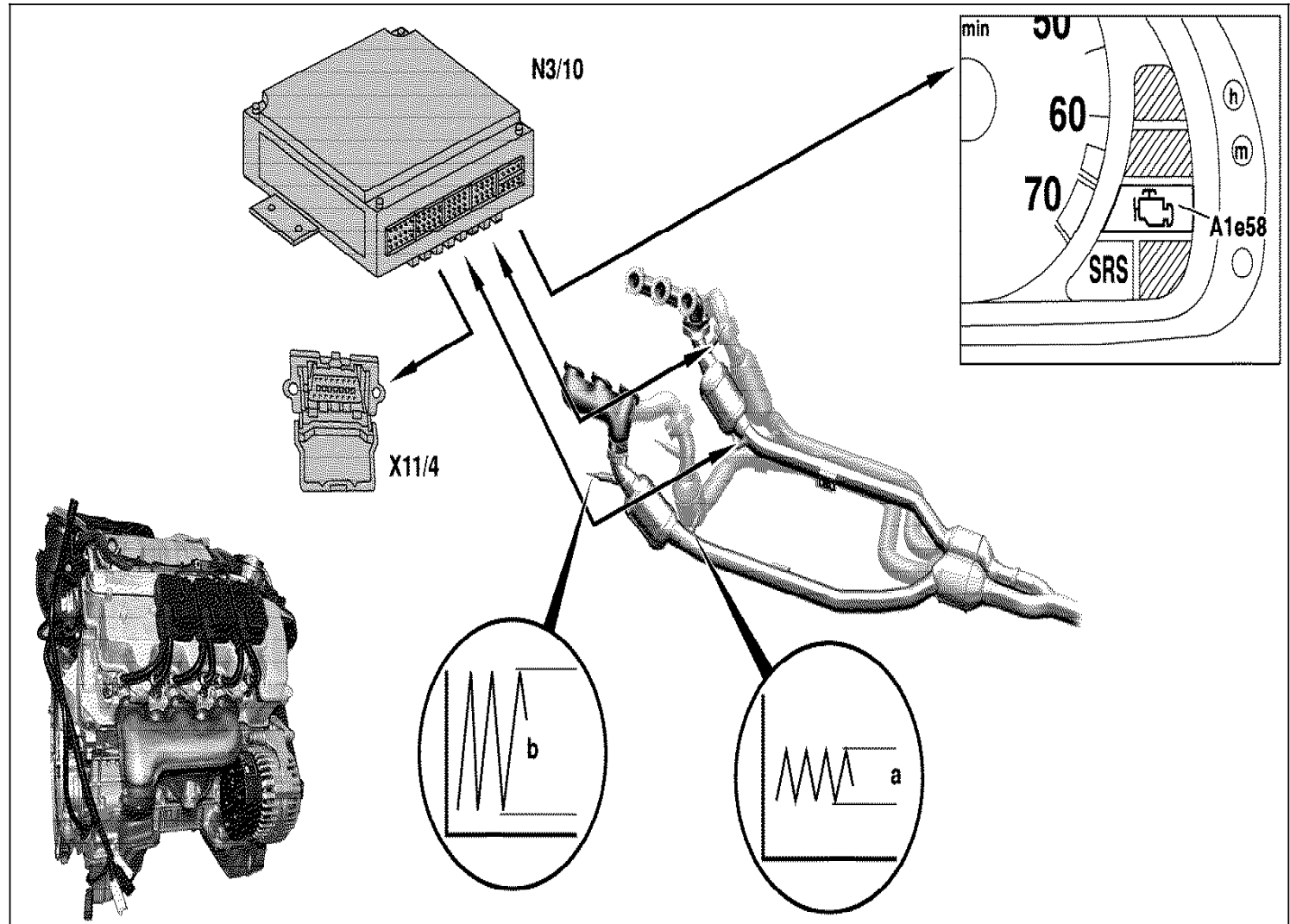

Figure 4
Engine 112 (not USA) shown

- A1e58 Engine diagnostic indicator lamp
- N3/10 Control module ME
- X11/4 Data link connector (DTC readout)
- a Amplitude of O2 sensor signal after CAT
- b Amplitude of O2 sensor signal before CAT

P49.10-2116-09

Diagnosis – Diagnostic Trouble Code (DTC) Memory

Figure 5
Engine CAN data bus
Models 129, 140, 163, 170, 202, 203, 208 210

- A1 Instrument cluster
- N3/4 Engine control module (HFM-SFI)
- N3/5 Engine maangement monolith control module (not (USA))
- N3/10 Engine control module (ME-SFI)
- N15/3 ETC control module
- N15/4 Automatic clutch control module (not (USA))
- N19/1 A/C pushbutton control module
- N22 AAC control unit and module
- N47-1 ASR/SPS control module
- N47-2 ETS/SPS control module
- N47-5 ESP/BAS control module
- N47-7 ABS control module
- N54 RCL control module
- N54/4 DAS radio frequency/infrared control module
- N65 Pulse module (traction systems, HCS,ATA, AAC)
- Y3/7n2 FWD control module (not (USA))

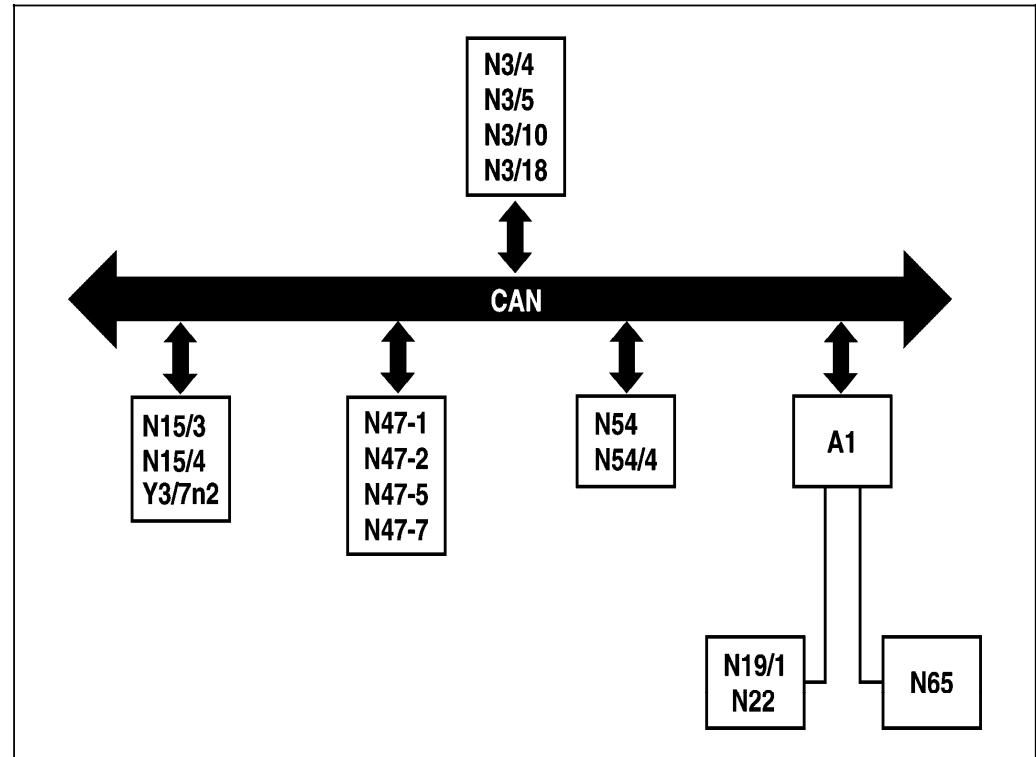

P54.18-2146-75